

**SONY®**

3-870-909-12(1)

# Mini HI-FI Component System

Operating Instructions

MHC-GZR9D

MHC-GZR8D

MHC-GZR7D



## WARNING

To reduce the risk of fire, do not cover the ventilation opening of the apparatus with newspapers, tablecloths, curtains, etc. Do not place the naked flame sources such as lighted candles on the apparatus.

To reduce the risk of fire or electric shock, do not expose this apparatus to dripping or splashing, and do not place objects filled with liquids, such as vases, on the apparatus.

As the main plug is used to disconnect the unit from the mains, connect the unit to an easily accessible AC outlet. Should you notice an abnormality in the unit, disconnect the main plug from the AC outlet immediately.

Do not install the appliance in a confined space, such as a bookcase or built-in cabinet.

Do not expose batteries or apparatus with battery-installed to excessive heat such as sunshine, fire or the like.

The unit is not disconnected from the mains as long as it is connected to the AC outlet, even if the unit itself has been turned off.

Excessive sound pressure from earphones and headphones can cause hearing loss.

## CAUTION

The use of optical instruments with this product will increase eye hazard.

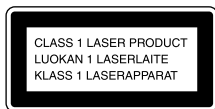

This appliance is classified as a CLASS 1 LASER product. This marking is located on the rear exterior.

## Notice for the customer in the countries applying EU Directives

The manufacturer of this product is Sony Corporation, 1-7-1 Konan, Minato-ku, Tokyo, 108-0075 Japan.

The Authorized Representative for EMC and product safety is Sony Deutschland GmbH, Hedelfinger Strasse 61, 70327 Stuttgart, Germany.

For any service or guarantee matters please refer to the addresses given in separate service or guarantee documents.



**Disposal of Old Electrical & Electronic Equipment (Applicable in the European Union and other European countries with separate collection systems)**

This symbol on the product or on its packaging indicates that this product shall not be treated as household waste. Instead it shall be handed over to the applicable collection point for the recycling of electrical and electronic equipment. By ensuring this product is disposed of correctly, you will help prevent potential negative consequences for the environment and human health, which could otherwise be caused by inappropriate waste handling of this product. The recycling of materials will help to conserve natural resources. For more detailed information about recycling of this product, please contact your local Civic Office, your household waste disposal service or the shop where you purchased the product.  
Applicable accessories: Remote commander



**Disposal of waste batteries (applicable in the European Union and other European countries with separate collection systems)**

This symbol on the battery or on the packaging indicates that the battery provided with this product shall not be treated as household waste. By ensuring these batteries are disposed of correctly, you will help prevent potentially negative consequences for the environment and human health which could otherwise be caused by inappropriate waste handling of the battery. The recycling of the materials will help to conserve natural resources. In case of products that for safety, performance or data integrity reasons require a permanent connection with an incorporated battery, this battery should be replaced by qualified service staff only. To ensure that the battery will be treated properly, hand over the product at end-of-life to the applicable collection point for the recycling of electrical and electronic equipment.

For all other batteries, please view the section on how to remove the battery from the product safely. Hand the battery over to the applicable collection point for the recycling of waste batteries.

For more detailed information about recycling of this product or battery, please contact your local Civic Office, your household waste disposal service or the shop where you purchased the product.

**Note on power cord plug shapes (Saudi Arabian model only)**

**For AC 220 V wall sockets**

- 1 Make the appropriate voltage setting on the system (only for models with a voltage selector).

- 2 Make sure that the 13 A 3-pin plug (Type BF) is securely attached to the power cord. (The 13 A 3-pin plug is attached when shipped from the factory.)

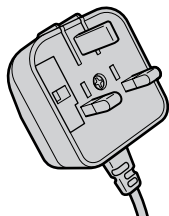

**For AC 127 V wall sockets**

- 1 Make the appropriate voltage setting on the system (only for models with a voltage selector).
- 2 Remove the 13 A 3-pin plug using a screwdriver.

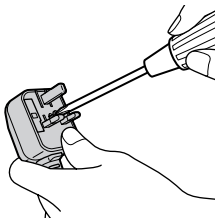

- 3 Attach the supplied parallel blade plug (Type A).

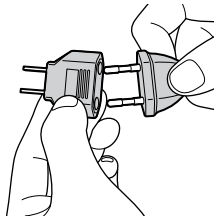

---

## About this manual

- The instructions in this manual are for models MHC-GZR9D, MHC-GZR8D and MHC-GZR7D. Each model consists of the following components.

### MHC-GZR9D

Unit:

HCD-GZR9D

Speaker system:

SS-GZR9D (Front speakers)

SS-RSX9D (Surround speakers)

SS-CTX9D (Center speaker)

SS-WGV9D (Subwoofer)

### MHC-GZR8D

Unit:

HCD-GZR8D

Speaker system:

SS-GZR8D (Front speakers)

SS-RSX9D (Surround speakers)

SS-CTX9D (Center speaker)

### MHC-GZR7D

Unit:

HCD-GZR7D

Speaker system:

SS-GZR8D (Front speakers)

In this manual, the MHC-GZR9D is used for illustration purposes unless stated otherwise.

- Icons, such as , listed at the top of each explanation indicate what kind of media can be used with the function being explained.
- The Control Menu items may be different depending on the disc.
- The Control Menu items may vary depending on the area.
- The Setup Menu items may be different depending on the area.
- The order of the displayed items may be different from the actual display.

# Table of Contents

About this manual .....	4
Playable discs .....	7
Guide to parts and controls .....	12

## Getting Started

Hooking up the system.....	20
Hooking up the TV.....	26
Positioning the speakers.....	30
Setting the clock .....	33
Performing "QUICK" setup .....	34
Using the "THEATRE SYNC" function .....	36

## Disc

Playing a disc .....	38
– Normal Play	
Using play mode .....	44
Searching/selecting a disc.....	49
Playing MP3/JPEG discs .....	52
Enjoying DivX® video files.....	57
Adjusting the delay between the picture and sound .....	59
– "A/V SYNC"	
Restricting playback of the disc....	60
– PARENTAL CONTROL	
Using the Setup Menu .....	63

## Tuner

Listening to the radio .....	71
------------------------------	----

## Tape

Playing a tape.....	74
Recording onto a tape .....	75

## USB Device

Transferring music from a disc to an USB device.....	78
Recording analog audio to an USB device .....	83
Listening to music of an USB device .....	85

## Sound Adjustment

Adjusting the sound .....	94
Singing along: Karaoke .....	98

## Other Operations













Using the timer .....	105
Changing the display .....	107
Viewing information about the disc .....	108
Hooking up optional components.....	113

Continued 

## Additional Information

Troubleshooting.....	118
Precautions.....	133
Specifications .....	135
Guide to the Control Menu display.....	139
Language code list .....	143
Glossary .....	145
Index.....	150

# Playable discs

Type	Characteristics	Icon used in this manual	Logo
DVD VIDEO	<ul style="list-style-type: none"> <li>• DVD VIDEO</li> <li>• DVD-R*/-RW*/+R/+RW in DVD VIDEO format</li> </ul> <p>* also in video mode</p>		
VR mode	<ul style="list-style-type: none"> <li>• DVD-R/-RW in VR (Video Recording) mode (except for DVD-R DL)</li> </ul>		
VIDEO CD	<ul style="list-style-type: none"> <li>• VIDEO CD (Ver. 1.1 and Ver. 2.0)</li> <li>• Super VCD</li> <li>• CD-R*/-RW*</li> </ul> <p>* in VIDEO CD or Super VCD format</p>		
CD	<ul style="list-style-type: none"> <li>• AUDIO CD</li> <li>• CD-R*/-RW*</li> </ul> <p>* in AUDIO CD format</p>		 
DATA CD	<ul style="list-style-type: none"> <li>• CD-ROM/-R/-RW in DATA CD format, containing MP3 audio tracks<sup>1)</sup>, JPEG image files<sup>2)</sup> or DivX video files<sup>3)</sup>, and conforming to ISO 9660<sup>4)</sup> Level 1 or Level 2, or Joliet (expansion format)</li> </ul>		   

Continued 

Type	Characteristics	Icon used in this manual	Logo
DATA DVD	<ul style="list-style-type: none"> <li>DVD-ROM/-R/-RW/+R/+RW in DATA DVD format containing MP3 audio tracks<sup>1)</sup>, JPEG image files<sup>2)</sup> or DivX video files<sup>3)</sup>, and conforming to UDF (Universal Disk Format)</li> </ul>		

This system can also play back discs with the following disc logos:



- <sup>1)</sup> MP3 (MPEG 1 Audio Layer 3) is a standard format defined by ISO/MPEG which compresses audio data. MP3 audio tracks must be in MPEG 1 Audio Layer 3 format.
- <sup>2)</sup> JPEG image files must conform to the DCF image file format (DCF “Design rule for Camera File System”: Image standards for digital cameras regulated by “Japan Electronics and Information Technology Industries Association” (JEITA)).
- <sup>3)</sup> DivX video files must be recorded in DivX format with the extension “.avi” or “.divx”.
- <sup>4)</sup> A logical format of files and folders on CD-ROMs, defined by ISO (International Organization for Standardization)

“DVD+RW,” “DVD-RW,” “DVD+R,” “DVD VIDEO,” and the “CD” logos are trademarks.



## Discs that cannot be played

- CD-ROMs recorded in PHOTO CD format
- DATA CDs recorded in MP3 PRO format
- Data part of CD-Extras<sup>1)</sup>
- Data part of Mixed CDs<sup>2)</sup>
- Super Audio CDs
- DVD Audio discs
- DVD-RAMs
- CPRM compatible DVD-R/RW recorded in Copy-once programs<sup>3)</sup>
- Discs of non-standard shape (for example, heart, square, star)
- Discs that have adhesive tape, paper, or sticker attached to them
- Rental or used discs with attached seals where the glue extends beyond the seal
- Discs that have labels printed using ink that feels tacky when touched

<sup>1)</sup> CD-Extra: This format records audio (AUDIO CD data) on the tracks in session 1 and data on the tracks in session 2.

<sup>2)</sup> Mixed CD: This format records data on the first track and audio (AUDIO CD data) on the second and subsequent tracks of a session.

<sup>3)</sup> CPRM: "Content Protection for Recordable Media" is a coding technology that protects copyright for Copy-Once programs.

## Region code of DVD VIDEOS you can play back on this system

Your system has a region code printed on the back of the unit and will only play back DVD VIDEOS labeled with identical region code.

DVD VIDEOS labeled  will also be played back on this system.

If you try to play back any other region code DVD VIDEO, the message "Playback prohibited by area limitations." will appear on the TV screen. Depending on the DVD VIDEO, no region code indication may be labeled even though playing the DVD VIDEO is prohibited by area restrictions.

## Note on DualDiscs

A DualDisc is a two sided disc product which mates DVD recorded material on one side with digital audio material on the other side. However, since the audio material side does not conform to the Compact Disc (CD) standard, playback on this product is not guaranteed.

## Notes on CD-R/-RW and DVD-R/-RW/+R/+RW

- In some cases, CD-Rs/-RWs and DVD-Rs/-RWs/+Rs/+RWs cannot be played back on this system due to the recording quality or physical condition of the disc, or the characteristics of the recording device and authoring software. The disc will not be played back if it has not been correctly finalized. For more information, see the operating instructions for the recording device.
- Note that some playback functions may not work with some DVD+Rs/+RWs, even if they have been correctly finalized. In this case, view the disc by normal playback.
- A disc created in Packet Write format cannot be played back.

## Note on playback operations of DVD VIDEOS and VIDEO CDs

Some playback operations of DVD VIDEOS and VIDEO CDs may be intentionally set by software producers. Since this system play back DVD VIDEOS and VIDEO CDs according to the disc contents the software producers designed, some playback features may not be available. Also, refer to the instructions supplied with the DVD VIDEOS or VIDEO CDs.

## Music discs encoded with copyright protection technologies

This product is designed to play back discs that conform to the Compact Disc (CD) standard. Recently, various music discs encoded with copyright protection technologies are marketed by some record companies. Please be aware that among those discs, there are some that do not conform to the CD standard and may not be playable by this product.

## Notes on Multi Session disc

- If the first session is recorded in AUDIO CD or VIDEO CD format, only the first session will be played back.
- The system will recognize a Multi Session disc as an AUDIO CD if there is a session recorded in AUDIO CD format on the disc. However, the system will only play back the disc if the first session is recorded in AUDIO CD format.
- This system can play back Multi Session discs when an MP3 audio track, a JPEG image file or a DivX video file is contained in the first session. Any subsequent MP3 audio tracks, JPEG image files or DivX video files recorded in later sessions can also be played back.
- With DATA CD or DATA DVD, the system will only play back DivX video files even if it contains MP3 audio tracks or JPEG image files.

## Copyrights

This product incorporates copyright protection technology that is protected by U.S. patents and other intellectual property rights. Use of this copyright protection technology must be authorized by Macrovision, and is intended for home and other limited viewing uses only unless otherwise authorized by Macrovision. Reverse engineering or disassembly is prohibited.

This system incorporates Dolby<sup>1)</sup> Digital, Dolby Pro Logic (II) adaptive matrix surround decoder, and DTS<sup>2)</sup> Digital Surround System.

<sup>1)</sup> MHC-GZR9D/GZR8D:

Manufactured under license from Dolby Laboratories. "Dolby," "Pro Logic," and the double-D symbol are trademarks of Dolby Laboratories.

MHC-GZR7D:

Manufactured under license from Dolby Laboratories. "Dolby" and the double-D symbol are trademarks of Dolby Laboratories.

<sup>2)</sup> MHC-GZR9D/GZR8D:

Manufactured under license under U.S. Patent #'s: 5,451,942; 5,956,674; 5,974,380; 5,978,762; 6,487,535 & other U.S. and worldwide patents issued & pending. DTS and DTS Digital Surround are registered trademarks and the DTS logos and Symbol are trademarks of DTS, Inc. ©1996-2007 DTS, Inc. All Rights Reserved.

MHC-GZR7D:

Manufactured under license under U.S. Patent #'s: 5,451,942; 5,956,674; 5,974,380; 5,978,762; 6,487,535 & other U.S. and worldwide patents issued & pending. DTS and DTS 2.0 + Digital Out are registered trademarks and the DTS logos and Symbol are trademarks of DTS, Inc. ©1996-2007 DTS, Inc. All Rights Reserved.

- DivX® is a video file compression technology, developed by DivX, Inc. DivX, DivX Certified, and associated logos are trademarks of DivX, Inc. and are used under license.
- MPEG Layer-3 audio coding technology and patents licensed from Fraunhofer IIS and Thomson.
- Windows Media is a registered trademark of Microsoft Corporation in the United States and/or other countries.

# Guide to parts and controls

This manual mainly explains operations using the remote, but the same operations can also be performed using the buttons on the unit having the same or similar names.

## Unit

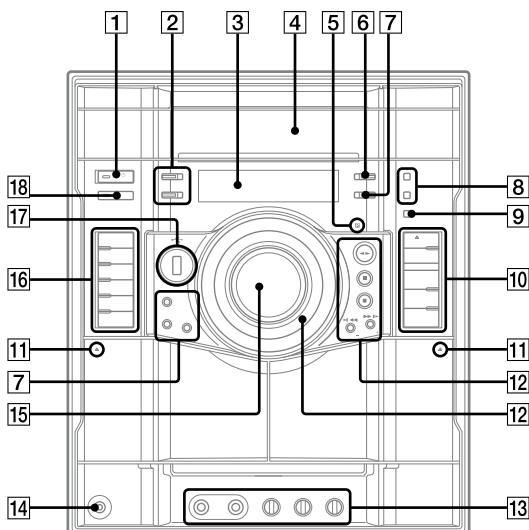

## Remote

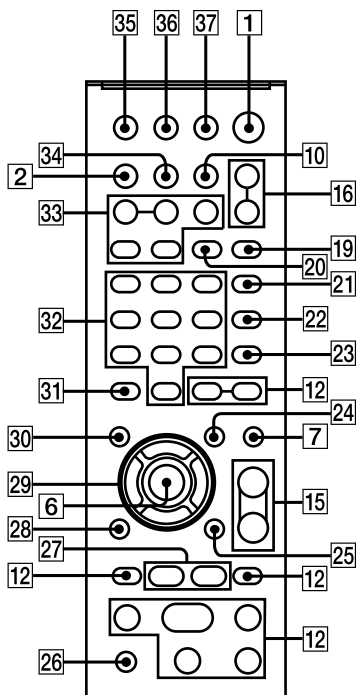

**1**  
I/O (on/standby) (24, 79, 106, 129)

Press to turn on or off the system.

Unit: STANDBY indicator (118)

Lights up when the system is turned off.

Remote: TV I/O<sup>1)</sup> (on/standby) (29)

Press to turn on or off the TV.

**2**  
DISPLAY (27, 33, 73, 107, 108)

Press to display the disc information or clock in the front panel display.

Unit: ILLUMINATION (108, 129)

Press to change the illumination pattern around MASTER VOLUME **15**.

**3**  
Display

**4**  
Disc tray

**5**  
Remote sensor

Continued

**6**

**ENTER** (28, 33, 34, 39, 44, 49, 53, 58, 59, 60, 63, 71, 74, 76, 79, 83, 87, 95, 102, 105, 129)

Press to enter the settings.

**7**

**SOUND FIELD** (95)

Press to select the sound field for the surround sound.

**Unit: GROOVE** (94)

Press to reinforce the bass.

**Unit: PRESET EQ** (94)

Press to select the sound effect.

**Unit: EQ BAND/MEMORY** (95)

Press to select the frequency band when adjusting the equalizer.

**8**

**REC TO USB** (79, 83)

Press to transfer music from a disc or record the sound from an analog audio source to the connected optional USB device.

Press to mark track numbers during recording.

**REC TO TAPE** (76)

Press to record on a tape.

**9**

**OPTIONS** (74, 75, 107, 116)

Press to enter the option menus.

**10**

**Unit: ▲ OPEN/CLOSE** (38)

Press to load or eject a disc.

**Unit: DISC SKIP/EX-CHANGE** (38, 40)

Press to select a disc.

Press to exchange a disc while playing.

**Remote: DISC SKIP** (40, 79)

Press to select a disc.

**Unit: DISC 1 — DISC 3** (40, 76, 79)

Press to select a disc.

Press to switch to the “DVD” function from other function.

**11**

**▲ PUSH/PUSH ▲** (74)

Press to insert or eject a tape.

**12**

**Unit: ◀▶ (play)** (26, 38, 74, 87)

**Remote: ▷<sup>2</sup> (play)** (38, 74, 87)

Press to start playback.

**■ (pause)** (27, 39, 75)

Press to pause playback.

**■ (stop) (39, 72, 75, 79)**

Press to stop playback.

**◀◀/▶▶ (rewind/fast forward) (39, 75)**

Press to find a point in a track, chapter or video file.

**Unit: ◀▶ (39)****Remote: ◀◀ SLOW/ SLOW ▶▶ (39)**

Press to watch the slow-motion play.

**TUNING +/- (71, 72, 73)**

Press to tune in the desired station.

**Remote:  +/- (36, 39)**

Press to select a folder.

**Unit: OPERATION DIAL (39, 72, 74, 76, 95, 107)**

Turn to select a track, chapter or video file.

Turn to select the preset station.

**Remote: PRESET +/- (72)**

Press to select the preset station.

**Remote: ◀◀/▶▶ (go backward/forward) (35, 37, 39, 74, 88)**

Press to select a track, chapter or video file.

**Remote: TV CH +/-<sup>1)</sup> (29)**

Press to change the TV channels.

**13****MIC 1/MIC 2 jacks (77, 98)**

Connect a microphone.

**MIC 1 LEVEL/MIC 2 LEVEL (98)**

Turn to adjust the microphone volume.

**ECHO LEVEL (99)**

Turn to adjust the echo level.

**14****PHONES jack**

Connect the headphones.

**15****Unit: MASTER VOLUME (38, 99, 105, 108)**

Turn to adjust the volume.

**Remote: VOLUME +/-<sup>2)</sup> (38, 99, 105)**

Press to adjust the volume.

**Remote: TV VOL +/-<sup>1)2)</sup> (29)**

Press to adjust the TV volume.

Continued 

**16**

**Unit: DVD (26, 27, 34, 38, 76, 79, 98)**

Press to select the “DVD” function.

**Unit: USB (76, 81, 85, 98)**

Press to select the “USB” function.

**Unit: TAPE A/B (74, 75)**

Press to select the “TAPE” function.

Press to select “TAPE A” or “TAPE B.”

**Unit: TUNER/BAND (71, 72)**

Press to select the “TUNER” function.

Press to switch among FM and AM band.

**Unit: DMPORT (116)**

Press to select the “DMPORT” function.

**Unit: VIDEO/SAT (116)**

Press to select the “VIDEO” or “SAT” function.

**Remote: FUNCTION +/- (27, 34, 38, 71, 74, 79, 83, 85, 98, 116)**

Press to select the function.

**17**

**↔ (USB) port (78, 83, 85)**

Connect an optional USB device.

**↔ (USB) indicator**

Lights up in red when transferring or recording to the connected optional USB device or when erasing audio tracks or folders.

**18 (MHC-GZR9D only)**

**SUBWOOFER (30)**

Press to turn on or off the subwoofer.

**SUBWOOFER indicator (30)**

Lights up when the subwoofer is turned on.

**19**

**PICTURE NAVI (54, 89)**

Press to display the thumbnail pictures.

**20**

**REPEAT/FM MODE (48, 73, 93)**

Press to listen to a disc, an USB device, a single track or file repeatedly.

Press to select FM reception mode (monaural or stereo).

**21**

**AUDIO (41, 99, 112)**

Press to display the current audio signal on the TV screen.

**22**

**SUBTITLE (40)**

Press to switch the language of the subtitle (DVD VIDEO only).

**D. TUNING (72)**

Press to switch to the direct tuning mode.



**23****ANGLE (40)**

Press to change the angle (DVD VIDEO with multi-angles only).

**24****DVD/TUNER MENU (49, 52, 58, 71, 87)**

Press to display the menu items on the TV screen.

Press to preset the radio station.

**25****DISPLAY (28, 35, 44, 49, 55, 59, 60, 63, 80, 87, 102, 112, 139)**

Press to display the Control Menu on the TV screen.

The Control Menu is displayed only when the "DVD" function or "USB" function is selected.

**26****TV<sup>1)</sup> (29)**

Press to operate the TV functions.

**27****STEP II (39)**

Press to play one frame at a time when playback is paused.

**ADVANCE (39, 53, 58, 87)**

Press to advance the current scene during playback.

**REPLAY (39, 53, 58, 87)**

Press to replay the previous scene during playback.

**28****RETURN (43, 53, 59, 81, 88)**

Press to return to the previous menu on the TV screen.

**29****▲/▼/◀/▶ (28, 29, 44, 45, 49, 71, 80, 96, 105)**

Press to select the menu items.

**30****DVD TOP MENU (49)**

Press to display the DVD title on the TV screen.

**31****CLEAR (34, 36, 45, 51, 54, 70, 81, 89)**

Press to delete a pre-programmed track or file.

Press to erase audio tracks or folders from the connected optional USB device.

**-/--<sup>1)</sup> (29)**

Press to enter a single digit or double digit number.

**32****Numeric buttons<sup>2)</sup> (29, 39, 49, 60, 65, 72)**

Press to select a track, chapter or video file.

Press to enter a password.

**10/0<sup>1)</sup>**

Press to enter a double digit number.

Continued 

**33**

### KEY CONTROL **b/#** (101)

Press to change the key to suit your vocal range.

### SCORE (103)

Press to start or stop calculating your vocal score.

### KARAOKE MODE (99)

Press to select the Karaoke mode.

### KARAOKE PON (101)

Press to activate the “Karaoke Pon” function.

**34**

### TIME/TEXT (108, 110)

Press to change the information appearing in the front panel display or on-screen display.

**35**

### SLEEP (36, 105)

Press to set the Sleep Timer.

### TV INPUT<sup>1)</sup> (29)

Press to switch the input sources.

**36**

### TIMER MENU (33, 105)

Press to set the clock and the timers.

**37**

### THEATRE SYNC (36)

Press to activate the “THEATRE SYNC” function.

<sup>1)</sup> This button is used to operate a Sony TV. For details, see “Operating a Sony TV” (page 29).

<sup>2)</sup> The numeric button 5 **32**, TV VOL + **15**, VOLUME + **15** and **▷** **12** buttons on the remote have a tactile dot. Use the tactile dot as a reference when operating the system.

## Display

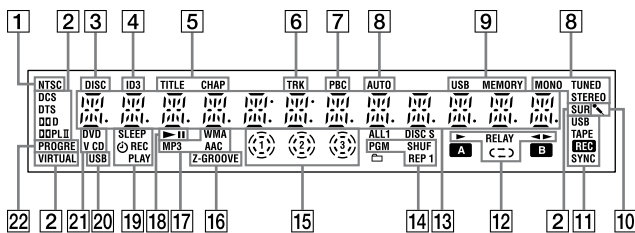

- 1 Lights up when the output video signal is NTSC. (27)
- 2 Indicates the current surround format.
- 3 Lights up when disc number is displayed.
- 4 Lights up when the ID3 tag information is displayed.
- 5 Lights up when the title or chapter number is displayed.
- 6 Lights up when the track information is displayed.
- 7 Lights up when playing VIDEO CD with PBC function. (42)
- 8 Lights up in "TUNER" function. (71)
- 9 Lights up when the USB device is recognized. (85)
- 10 Lights up when the Karaoke Mode is turned on. (98)
- 11 Lights up during transfer or recording. (75, 78, 83)
- 12 Indicates the tape playback direction. (74)
- 13 Displays the text information.
- 14 Indicates the selected play mode. (44)
- 15 Indicates the disc presence. (38)
- 16 Lights up when "GROOVE" or "Z-GROOVE" is turned on. (94)
- 17 Indicates the file format.
- 18 Indicates the playback status of the disc or USB device.
- 19 Lights up when the timer is set. (105)
- 20 Lights up when the "USB" function is selected. (85)
- 21 Indicates the type of disc being played back. (38)
- 22 Lights up when "PROGRESSIVE (COMPONENT OUT)" is set to "ON." (28)

# Getting Started

## Hooking up the system

MHC-GZR9D

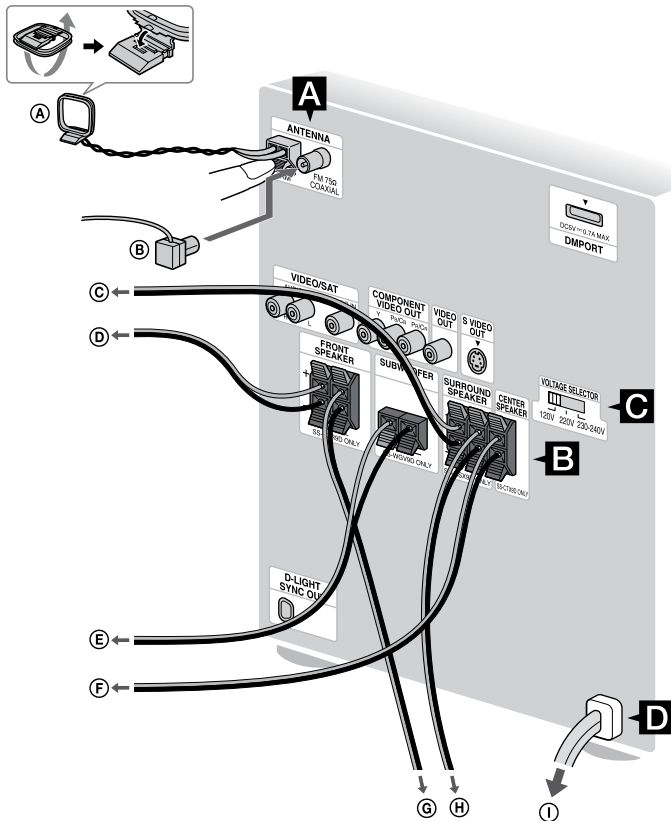

- A** AM loop antenna
- B** FM lead antenna (Extend it horizontally.)
- C** Surround speaker (Right)
- D** Front speaker (Right)
- E** Subwoofer

- F** Center speaker
- G** Front speaker (Left)
- H** Surround speaker (Left)
- I** Wall socket

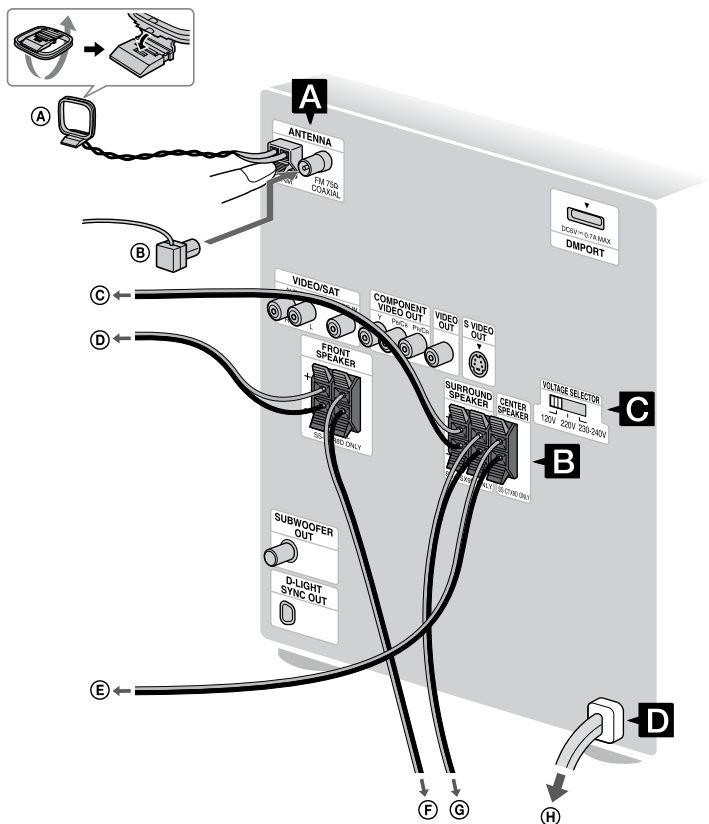

- Ⓐ AM loop antenna
- Ⓑ FM lead antenna (Extend it horizontally.)
- Ⓒ Surround speaker (Right)
- Ⓓ Front speaker (Right)

- Ⓔ Center speaker
- Ⓕ Front speaker (Left)
- Ⓖ Surround speaker (Left)
- Ⓗ Wall socket

Continued

## MHC-GZR7D

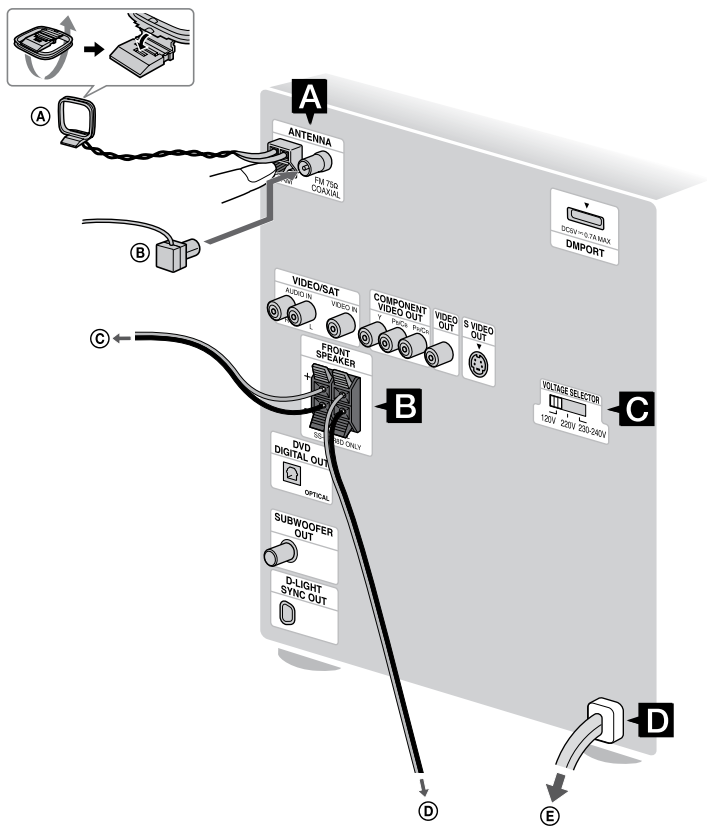

- A** AM loop antenna
- B** FM lead antenna (Extend it horizontally.)
- C** Front speaker (Right)

- D** Front speaker (Left)
- E** Wall socket

## A FM/AM antennas

Find a location and an orientation that provide good reception, and then set up the antenna.

Keep the antennas away from the speaker cords, the power cord and the USB cable to avoid picking up noise.

## B Speakers

Insert only the stripped portion of the speaker cords.

The speaker cords are color-coded with their respective speaker terminals.

The type of speakers supplied varies according to the model you purchased (see “About this manual” (page 4)).

### Front speakers

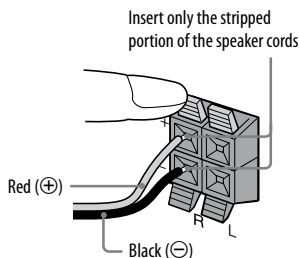

### Surround speakers (MHC-GZR9D/GZR8D only)

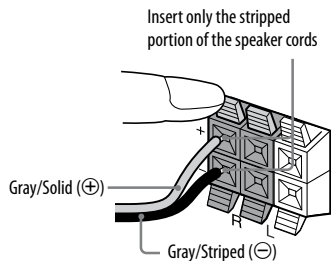

### Center speaker (MHC-GZR9D/GZR8D only)

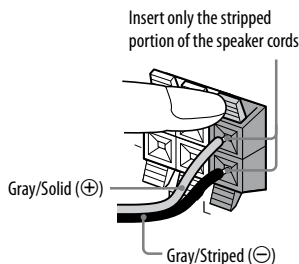

## Terminals on the center and surround speakers (MHC-GZR9D/GZR8D only)

Connect the speaker cords to the terminals on the center and surround speakers as shown below.

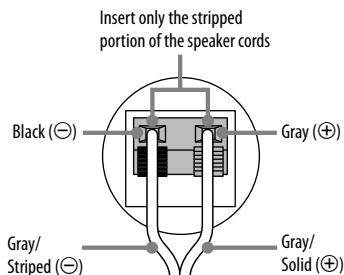

## Subwoofer (MHC-GZR9D only)

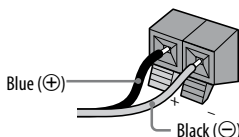

## Notes

- Be sure to connect the speakers securely and correctly.
- Be sure to match the speaker cord to the appropriate terminal on the components: ⊕ to ⊕ and ⊖ to ⊖. If the cords are reversed, the sound will be distorted and will lack bass.

## C Voltage selector

For models with a voltage selector, set VOLTAGE SELECTOR to the local power line voltage.

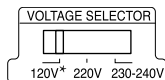

\* Saudi Arabian model: 120 – 127 V

## D Power

Connect the power cord to a wall socket. The demonstration appears in the display. When you press I/⏻ [1], the system turns on and the demonstration automatically ends.

If the supplied adapter on the plug does not fit your wall socket, detach it from the plug (only for models equipped with an adapter).



## Inserting two R6 (size AA) batteries into the remote

Slide and remove the battery compartment lid, and insert the two supplied R6 (size AA) batteries,  $\ominus$  side first, matching the polarities shown below.

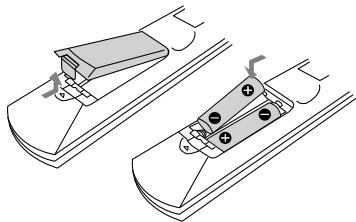

### Note

If you do not use the remote for a long period of time, remove the batteries to avoid possible damage from battery leakage and corrosion.

### Tip

With normal use, the batteries should last for about six months. When the remote no longer operates the system, replace both batteries with new ones.

## Attaching the speaker pads

Attach the supplied speaker pads at each corner on the bottom of the speakers to prevent them from slipping.

### Front speakers (Left (4)/Right (4))/ Subwoofer (4)<sup>1)</sup>

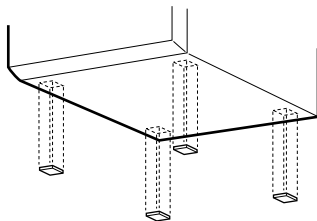

### Center speaker (4)<sup>2)</sup>/Surround speakers (Left (4)/Right (4))<sup>2)</sup>

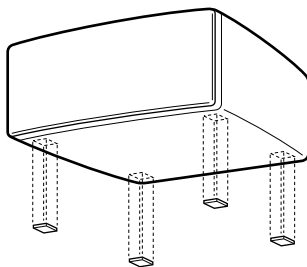

<sup>1)</sup> MHC-GZR9D only

<sup>2)</sup> MHC-GZR9D/GZR8D only

### When carrying this system

Perform the following procedure to protect the DVD mechanism. Use buttons on the unit for the operation.

- 1 Press I/⏻ 1 to turn on the system, then press DVD 16.
- 2 Make sure that no disc is loaded in the system and check that "DVD NO DISC" appears.
- 3 Hold down ◀▶ 12 and then press I/⏻ 1 until "STANDBY" appears in the display. Then, "LOCK" appears in the display.
- 4 Unplug the power cord.

## Hooking up the TV

Connect the video input jack of your TV to the VIDEO OUT jack with the supplied video cord.

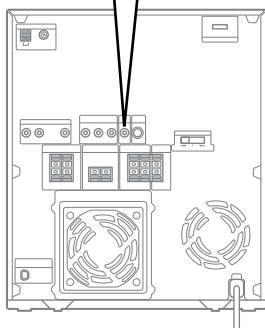
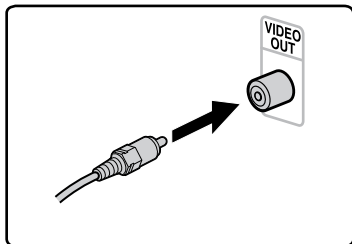

## When connecting a video deck

Connect the video deck to the TV using a video cord (not supplied). However, do not connect this unit to the TV through the video deck. Otherwise, you may experience video leakage when watching video images from this system. Connect this unit directly to the TV as shown below.

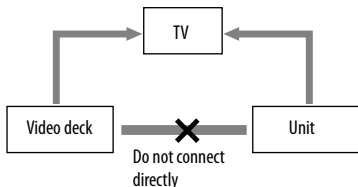

### Tip

For higher quality video images:

- Use the optional component video cords to connect the COMPONENT VIDEO input jacks on your TV to the COMPONENT VIDEO OUT jacks of this unit. If your TV is compatible with progressive format signals, use this connection and set “PROGRESSIVE (COMPONENT OUT)” to “ON” (page 28).
- You can use an optional S Video cord to connect the S VIDEO input jack on your TV to the S VIDEO OUT jack of this unit.

## Changing the color system

(Except for Russian and Latin American models)

Set the color system to PAL or NTSC depending on the color system of your TV.

The default setting for color system is different depending on the area.

Each time you perform the procedure below, the color system changes as follows:

NTSC ↔ PAL

- 1 Press I/⏻ [1] to turn on the system.
- 2 Press FUNCTION +/- [16] repeatedly to select “DVD” (or press DVD [16] on the unit).
- 3 Press I/⏻ [1] to turn off the system.
- 4 Press DISPLAY [2] repeatedly until “SONY DEMO” appears in the display.
- 5 Press I/⏻ [1] on the unit while holding down ■ [12] on the unit. The system turns on automatically and the color system is changed. “COLOR NTSC” or “COLOR PAL” appears in the display.

Continued

## Changing the format of the video signal output from COMPONENT VIDEO OUT jacks

Progressive is a method for displaying TV images that reduces flickering and sharpens the image. To use this method, you need to connect to a TV that can accept progressive signals.

You can output video signals from COMPONENT VIDEO OUT jacks in Interlace or Progressive format.

- 1 Press **FUNCTION +/-** **[16]** repeatedly to select “DVD” (or press **DVD** **[16]** on the unit).
- 2 Press **DISPLAY** **[25]** when playback is stopped.  
The Control Menu appears on the TV screen.
- 3 Press **↑** or **↓** **[29]** repeatedly to select **[SETUP]** (SETUP), then press **ENTER** **[6]**.  
The options for “SETUP” appear.
- 4 Press **↑** or **↓** **[29]** repeatedly to select “CUSTOM,” then press **ENTER** **[6]**.  
The Setup Menu appears.

- 5 Press **↑** or **↓** **[29]** repeatedly to select “VIDEO SETUP,” then press **ENTER** **[6]**.

The options for “VIDEO SETUP” appear.

- 6 Press **↑** or **↓** **[29]** repeatedly to select “PROGRESSIVE (COMPONENT OUT),” then press **ENTER** **[6]**.

The options for “PROGRESSIVE (COMPONENT OUT)” appear.

- 7 Press **↑** or **↓** **[29]** repeatedly to select the desired setting, then press **ENTER** **[6]**.

The default setting is underlined.

- OFF: Outputs interlace signals.  
Select this setting when:
  - your TV does not accept progressive signals.
  - your TV is connected to jacks other than the COMPONENT VIDEO OUT jacks.
- ON: Outputs progressive signals.  
Select this setting when:
  - your TV accepts progressive signals.
  - your TV is connected to the COMPONENT VIDEO OUT jacks.

When you select “ON,” the confirmation display appears. Follow the steps below.

- 8 Press ◀ or ▶ [29] repeatedly to select "START," then press ENTER [6].

The system outputs the progressive signal for 5 seconds. Check that the screen is displayed correctly.

- 9 Press ◀ or ▶ [29] repeatedly to select "YES."

The system outputs the progressive signal. When you select "NO," the system does not output the progressive signal.

### Note

There would be no image on your TV or the image is not clear if your setting does not match your TV or connection.

## When using a TV

Turn on the TV and select the video input so that you can view the pictures from this system.

### Operating a Sony TV

You can use the following buttons to operate a Sony TV. These buttons have been marked in orange.

To	Press
Turn the TV on or off	TV I/⏻ [1] while holding down TV [26]
Switch the TV's input source between the TV and other input sources	TV INPUT [35] while holding down TV [26]
Select the TV channels	TV CH +/- [12] or numeric buttons [32]* while holding down TV [26]
Adjust the volume of the TV speaker(s)	TV VOL +/- [15] while holding down TV [26]

\* For double digit number, hold down TV [26] and press -/- [31], then press the number. (For example, hold down TV [26], press -/- [31], then 2 and 5 for entering 25.)

## Positioning the speakers

- 1 Place the front speakers at an angle of 45 degrees from your listening position.

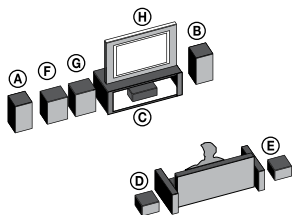

- (A) Front speaker (left)
- (B) Front speaker (right)
- (C) Center speaker (MHC-GZR9D/GZR8D only)
- (D) Surround speaker (left) (MHC-GZR9D/GZR8D only)
- (E) Surround speaker (right) (MHC-GZR9D/GZR8D only)
- (F) Subwoofer (MHC-GZR9D only)
- (G) Unit
- (H) TV

- 2 (MHC-GZR9D/GZR8D only)  
Place the center speaker at about the same height as the front speakers.

Align the center speaker with the front speakers or place it slightly behind the front speakers.

- 3 (MHC-GZR9D/GZR8D only)  
Place the surround speakers.

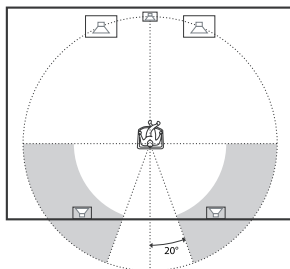

Position the surround speakers within the respective gray ranges. Positioning both surround speakers the same distance from the listening position is effective.

- 4 (MHC-GZR9D only)  
Place the subwoofer, then press SUBWOOFER **18** on the unit.

The SUBWOOFER indicator **18** on the unit lights up.

To obtain a better bass reproduction, we recommend you to place the subwoofer on a solid floor where resonance is unlikely to occur.

## Notes

- Do not place the surround speakers on top of a TV.<sup>1)</sup> This may cause distortion of the colors in the TV screen.
- Be sure to connect the both left and right surround speakers.<sup>1)</sup> Otherwise, the sound will not be heard.
- Always place the subwoofer vertically, keeping it a few centimeters away from the wall.<sup>2) 3)</sup>
- If the subwoofer is placed in the center of a room, the bass could be extremely weakened.<sup>2) 3)</sup> This is due to the influence of the standing wave of the room. If this happens, move the subwoofer away from the center of the room or eliminate the cause of the standing wave, by placing a bookshelf against the wall, etc.

<sup>1)</sup> MHC-GZR9D/GZR8D only

<sup>2)</sup> MHC-GZR9D only

<sup>3)</sup> For MHC-GZR8D/GZR7D, the subwoofer is an option (sold separately). Refer to the subwoofer operating instructions for the detailed setting method.

## To install the surround speakers on the wall (MHC-GZR9D/GZR8D only)

- 1 Prepare screws (not supplied) that are suitable for the hole on the back of each speaker. See the illustrations below.

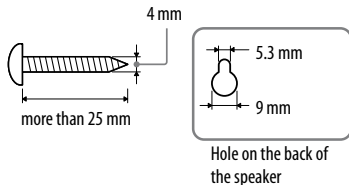

- 2 Fasten the screws to the wall. The screws should protrude 5.5 to 7 mm.

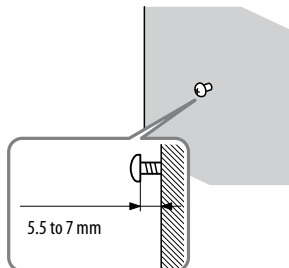

Continued 

### 3 Hang the speakers on the screws.

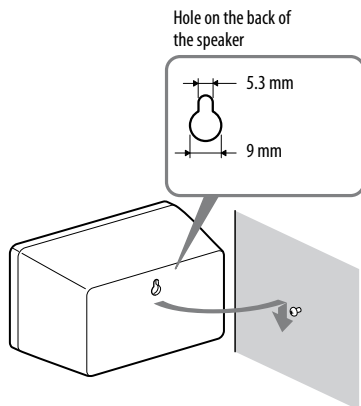

### Speaker settings

To enjoy DVD VIDEOS and other discs with multichannel sound and Dolby Surround effects, the speakers need to be adjusted. Set the distance from the listening position to the speakers, and the balance and level. Then use the test tone to adjust the volume of each speaker to the same level.

For details, see “Setting the speakers” (page 68).

### Notes

- Use screws that are suitable for the wall material and strength. As a plaster board wall is especially fragile, attach the screws securely to a beam and fasten them to the wall. Install the surround speakers on a vertical and flat wall where reinforcement is applied.
- Contact a screw shop or installer regarding the wall material or screws to be used.
- Sony is not responsible for accident or damage caused by improper installation, insufficient wall strength or improper screw installation, natural calamity, etc.



## Setting the clock

Use buttons on the remote to set the clock.

- 1 Press I/⏻ [1] to turn on the system.
- 2 Press TIMER MENU [36].  
The hour indication flashes in the display.  
If "PLAY SET" flashes in the display, press ⬆ or ⬇ [29] repeatedly to select "CLOCK SET," then press ENTER [6].
- 3 Press ⬆ or ⬇ [29] repeatedly to set the hour.
- 4 Press ENTER [6].  
The minute indication flashes in the display.
- 5 Press ⬆ or ⬇ [29] repeatedly to set the minutes.
- 6 Press ENTER [6].  
The clock starts functioning.

### Note

The clock settings are canceled when you disconnect the power cord or if a power failure occurs.

### To display the clock when the system is off

Press DISPLAY [2] repeatedly until the clock is displayed.

The clock is displayed for about 8 seconds.

## Performing “QUICK” setup

Before using the system, you can make the minimum basic adjustments in “QUICK” setup. If you do not want to perform “QUICK” setup, press CLEAR **[31]** in step 3. The guide message will disappear from the TV screen.

**1** Turn on your TV and select the video input.

**2** Press I/⏻ **[1]** to turn on the system.

### Notes

- Make sure there is no disc in the unit. Otherwise, the guide message does not appear.
- Make sure that the headphone or microphone is not connected. Otherwise, you cannot perform “SPEAKER SETUP.”

**3** Press FUNCTION +/- **[16]** repeatedly to select “DVD” (or press DVD **[16]** on the unit). The guide message appears at the bottom of the TV screen.

**4** Press ENTER **[6]** without loading a disc. “LANGUAGE SETUP” appears on the TV screen.

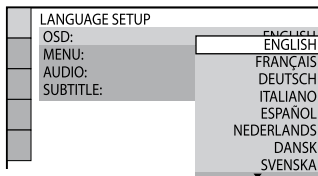

**5** Press ↑ or ↓ **[29]** repeatedly to select a language, then press ENTER **[6]**.

The setting is selected and “VIDEO SETUP” appears on the TV screen.

### Tips

- The selected language is for “OSD,” “MENU” and “SUBTITLE.”
- The selectable language is different depending on the area.

- 6 Press **▲** or **▼** [29] repeatedly to select the setting that matches your TV type.

**If you have a 4:3 standard TV:**

Select “4:3 LETTER BOX” or “4:3 PAN SCAN” (page 65, 66)

**If you have a wide-screen TV or a 4:3 standard TV with wide-screen mode:**

Select “16:9” (page 65)

- 7 Press ENTER [6].

**MHC-GZR9D/GZR8D:**

The setting is selected and the “SPEAKER SETUP” display appears on the TV screen. Go to step 8.

**MHC-GZR7D:**

The setting is selected and “QUICK SETUP is complete.” appears on the TV screen.

The system is ready for playback. If you want to change each setting individually, see “Using the Setup Menu” (page 63).

- 8 Press **▲** or **▼** [29] repeatedly to select the front speaker distance from your listening position, then press ENTER [6].

Repeat this step to adjust the center and surround speaker distance.

The setting is selected and “QUICK SETUP is complete.” appears on the TV screen.

The system is ready for playback. To perform further speaker settings, see “Setting the speakers” (page 68).

If you want to change each setting individually, see “Using the Setup Menu” (page 63).

**If you make a mistake**











Press **◀** [12], then select the item again.

**To quit “QUICK” setup**

Press **☐** DISPLAY [25].

Continued 

## To recall "QUICK" setup settings

- 1 Press  DISPLAY  when playback is stopped.  
The Control Menu appears on the TV screen.
- 2 Press  or   repeatedly to select  (SETUP), then press ENTER .
- 3 Press  or   repeatedly to select "QUICK," then press ENTER .

### Note

The guide message appears at the bottom of the TV screen when you turn on the system for the first time or after performing "RESET" (page 130).

## Using the "THEATRE SYNC" function





THEATRE SYNC  allows you to turn on your Sony TV and this system, changes the system's function to "DVD" and then switches the TV's input source you have set with just one button.

### Preparing to use the "THEATRE SYNC" function

Register the TV's input source connected to this system.

### To select the TV's input

Press the following buttons while holding down SLEEP .

Press	TV's input source
0	No input source (Default)
1 to 8	VIDEO 1 to VIDEO 8
9	COMPONENT 1
CLEAR 	COMPONENT 2
 - 	COMPONENT 3
 + 	COMPONENT 4

The selected TV's input source is memorized into the remote.

## Operating the "THEATRE SYNC" function

Keep the remote pointed in the direction of the TV until the TV is turned on and the input source is changed correctly, then press THEATRE SYNC **[37]**.

If this function does not work, change the transmission time. The transmission time varies depending on the TV.

### To change the transmission time

Press the following buttons while holding down **▶▶▶ [12]**.

Press	Transmission time
1	0.5 (Default)
2	1
3	1.5
4	2
5	2.5
6	3
7	3.5
8	4

#### Note

This function is only for Sony TV series, however, some TV products may also not work.

## Disc

### Playing a disc

— Normal Play



Depending on the DVD VIDEO or VIDEO CD, some operations may be different or restricted. Refer to the operating instructions supplied with the disc.

#### Note on the maximum number of tracks, files and folders on a DATA CD/DVD

This system cannot play a DATA CD/DVD in the following cases.

- When the number of tracks or files on a folder exceeds 150.
- When the number of folders on a disc exceeds 200.

These numbers may vary depending on the track structure, the file structure and the folder structure.

#### Example: When playing a DVD VIDEO

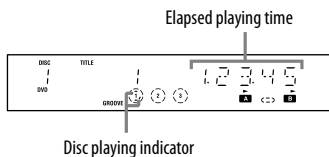

- 1 Press FUNCTION +/- [16] repeatedly to select "DVD" (or press DVD [16] on the unit).
- 2 Press ▲ OPEN/CLOSE [10] on the unit.

- 3 Load a disc with the label side facing up on the disc tray [4].

To load additional discs, press DISC SKIP/EX-CHANGE [10] on the unit to rotate the disc tray [4].

When you play back an 8 cm disc such as a CD single, place it on the inner circle of the tray

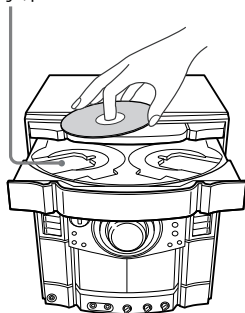

- 4 Press ▲ OPEN/CLOSE [10] on the unit to close the disc tray [4].

Do not forcibly push the disc tray to close it as this may cause a malfunction.

If the playback does not start automatically, press ▷ (or ◀▶ on the unit) [12].

- 5 Press VOLUME +/- (or turn MASTER VOLUME on the unit) [15] to adjust the volume.

#### Note

Depending on the system status, the volume level may not appear on the TV screen.

## Other operations

To	Do this
Stop playback	Press <b>■</b> <b>[12]</b> .
Pause playback	Press <b>  </b> <b>[12]</b> <sup>1)</sup> . Press <b>  </b> <b>[12]</b> again or press <b>▷</b> (or <b>◀▶</b> on the unit) <b>[12]</b> to resume playback.
Select a track, chapter or video file <sup>2)</sup>	Press <b>◀◀</b> or <b>▶▶</b> <b>[12]</b> repeatedly (or turn OPERATION DIAL <b>[12]</b> on the unit clockwise or counterclockwise) during playback. Or, press the numeric buttons <b>[32]</b> when the Control Menu is turned off, then press ENTER <b>[6]</b> <sup>3)</sup> .
Select a folder <sup>4)</sup>	Press <b>📁</b> <b>+/-</b> <b>[12]</b> repeatedly during playback or when playback is paused.
Locate a point quickly in fast forward or fast reverse (Lock Search) <sup>5)</sup>	Press <b>◀◀</b> or <b>▶▶</b> <b>[12]</b> during playback. Each time you press <b>◀◀</b> or <b>▶▶</b> <b>[12]</b> , the playback speed changes cyclically <sup>6)</sup> . To return to normal playback, press <b>▷</b> (or <b>◀▶</b> on the unit) <b>[12]</b> .
Watch frame by frame (Slow-motion Play) <sup>7)</sup>	Press <b>◀</b> <b>SLOW</b> or <b>SLOW</b> <b>▶</b> <b>[12]</b> when playback is paused. Each time you press <b>◀</b> <b>SLOW</b> <sup>8)</sup> or <b>SLOW</b> <b>▶</b> <b>[12]</b> , the playback speed changes. To return to normal playback, press <b>▷</b> (or <b>◀▶</b> on the unit) <b>[12]</b> .
Play one frame at a time (Freeze Frame) <sup>7)</sup>	Press <b>STEP</b> <b>  </b> <b>[27]</b> to go to the next frame when playback is paused. Press <b>◀</b> <b>STEP</b> <b>[27]</b> <sup>8)</sup> to go to the preceding frame when playback is paused. To return to normal playback, press <b>▷</b> (or <b>◀▶</b> on the unit) <b>[12]</b> .
Replay the previous scene	Press <b>◀</b> <b>•</b> <b>REPLAY</b> <b>[27]</b> during playback. (Instant Replay) <sup>9)</sup>
Briefly fast forward the current scene	Press <b>ADVANCE</b> <b>•▶</b> <b>[27]</b> during playback. (Instant Advance) <sup>9)</sup>

Continued 

To	Do this
Select a disc	Press DISC SKIP <b>[10]</b> on the remote (or one of DISC 1 – DISC 3 <b>[10]</b> on the unit).
Switch to DVD function from another source	Press one of DISC 1 – DISC 3 <b>[10]</b> on the unit (Automatic Source Selection).
Exchange other discs while playing	Press DISC SKIP/EX-CHANGE <b>[10]</b> on the unit.

- <sup>1)</sup> There may be some disturbance in the video image.
- <sup>2)</sup> Except for JPEG image files. You cannot select an audio track during Lock Search operation of MP3 audio tracks.
- <sup>3)</sup> DVD VIDEO, DVD-R/-RW in VR mode, VIDEO CD, AUDIO CD and DivX video file only.
- <sup>4)</sup> MP3 audio tracks, JPEG image files and DivX video files only.
- <sup>5)</sup> Except for JPEG image files.
- <sup>6)</sup> Depending on the disc, the actual speed may differ.
- <sup>7)</sup> DVD VIDEO, DVD-R/-RW in VR mode, DivX video files and VIDEO CD only.
- <sup>8)</sup> Except for VIDEO CD and DivX video file.
- <sup>9)</sup> DVD VIDEO and DVD-R/-RW in VR mode only.

### Notes

- You cannot search for a still picture on a DVD-R/-RW in VR mode.
- You may not be able to use the Instant Replay or Instant Advance function in Repeat Play mode or with some scenes.

## Displaying multi-angles and subtitles

### Changing the angles

(DVD VIDEO only)

You can change the viewing angle while playing a DVD VIDEO on which various angles (multi-angles) for a scene are recorded.

Press ANGLE **[23]** repeatedly during playback. Each time you press ANGLE **[23]**, the angle changes.

### Note

Depending on the DVD VIDEO, you may not be able to change the angle, even if multi-angles are recorded on the DVD VIDEO.

### Displaying the subtitles

(DVD VIDEO, DVD-R/-RW in VR mode and DivX video files only)

You can turn the subtitles on or off while playing a DVD VIDEO, DVD-R/-RW in VR mode or DivX video files on which subtitles are recorded. You can also change the language of the subtitles with DVD VIDEO, DVD-R/-RW in VR mode or DivX video files on which multilingual subtitles are recorded.

Press SUBTITLE **[22]** repeatedly during playback. Each time you press SUBTITLE **[22]**, the subtitle language changes or turns off.



## Notes

- Depending on the DVD VIDEO, you may not be able to change the subtitles even if multilingual subtitles are recorded on the DVD VIDEO. You also may not be able to turn the subtitles off.
- You can change the subtitles if the DivX video file has an “.avi” or “.divx” extension and contains subtitle information within the same file.

## Other useful functions

### Changing the sound

When playing a DVD VIDEO or a DivX video file recorded in multiple audio formats, you can select the audio format you want. If the DVD VIDEO is recorded with multilingual tracks, you can also change the language.

When playing a VIDEO CD, AUDIO CD or MP3 audio tracks, you can select the sound from the right or left channel and listen to the sound of the selected channel through both the right and left speakers. For example, when playing a track with the vocals on the right channel and the instruments on the left channel, you can hear the instruments from both speakers by selecting the left channel.

Press AUDIO 21 repeatedly during playback to select the audio signal you want.

The default setting is underlined.

### When playing a DVD VIDEO:

Depending on the DVD VIDEO, the option of language and audio format varies.

When a 4-digit number is displayed, the digits represent a language code (see “Language code list” (page 143)). When the same language is displayed two or more times, the DVD VIDEO is recorded in multiple audio formats. Note that the sound changes automatically depending on the disc.

### When playing a DVD-R/-RW in VR mode:

The number of audio tracks recorded on a disc are displayed.

Example:

- 1: MAIN: the main sound of the audio track 1.
  - 1: SUB: the sub sound of the audio track 1.
  - 1: MAIN+SUB: the main and sub sound of the audio track 1.
  - 2: MAIN\*: the main sound of the audio track 2.
  - 2: SUB\*: the sub sound of the audio track 2.
  - 2: MAIN+SUB\*: the main and sub sound of the audio track 2.
- \* These items do not appear if only one audio stream is recorded on the disc being played back.

**When playing a DivX video file:**

The options for audio format differ depending on the DivX video files.

**When playing a VIDEO CD, AUDIO CD, or MP3 audio track:**

- STEREO: the standard stereo sound.
- 1/L: the sound of the left channel (monaural).
- 2/R: the sound of the right channel (monaural).

**When playing a Super VCD:**

- 1: STEREO: the stereo sound of the audio track 1.
- 1: 1/L: the sound of the left channel of the audio track 1 (monaural).
- 1: 2/R: the sound of the right channel of the audio track 1 (monaural).
- 2: STEREO: the stereo sound of the audio track 2.
- 2: 1/L: the sound of the left channel of the audio track 2 (monaural).
- 2: 2/R: the sound of the right channel of the audio track 2 (monaural).

**Note**

While the system is playing a Super VCD on which the audio track 2 is not recorded, no sound will come out when you select "2: STEREO," "2: 1/L" or "2: 2/R."

**Playing VIDEO CDs with PBC functions (Version 2.0) — PBC Playback**

(VIDEO CD only)

You can use the PBC (Playback Control) menus on your TV screen to enjoy the disc's interactive software. The menu format and structure may differ depending on each disc.

- 1 Press  $\triangleright$  (or  $\blacktriangleleft\blacktriangleright$  on the unit)  $\boxed{12}$  to start playing a VIDEO CD with PBC functions (Version 2.0).  
The PBC menu appears on the TV screen. Depending on the VIDEO CD, the menu may not appear.
- 2 Press the numeric buttons  $\boxed{32}$  to select the item number you want.
- 3 Press ENTER  $\boxed{6}$ .  
Depending on the VIDEO CD, "Press ENTER" may appear as "Press SELECT" in the operating instructions supplied with the disc. In this case, press  $\triangleright$  (or  $\blacktriangleleft\blacktriangleright$  on the unit)  $\boxed{12}$ .
- 4 Continue playback according to the instructions on the menus.  
Refer to the operating instructions supplied with the VIDEO CD, as the operating procedure may differ depending on the VIDEO CD.



**To return to the previous menu**

Press  RETURN [28].

**Note**



PBC playback is canceled when Shuffle Play, Program Play or Repeat Play is activated.

**To cancel playback with PBC functions**

1 Press  or  [12] repeatedly or press the numeric buttons [32] to select a track when playback is stopped.

2 Press  (or  on the unit) [12] or ENTER [6].

Playback starts from the selected track. Still images, such as the menu screens, will not be shown.

To return to PBC playback, press  [12] twice, then press  (or  on the unit) [12].

**Resuming playback from the point you stopped the disc — Resume Play**

This system memorizes the point where you stopped the disc so you can resume playback from that point. Resume Play is not canceled when you turn off the system except for MP3 audio tracks, JPEG image files and DivX video files.

1 While playing a disc, press  [12] to stop playback.

“RESUME” appears in the display. If “RESUME” does not appear, Resume Play is not available.



2 Press  (or  on the unit) [12].

The system starts playback from the point you stopped the disc in step 1.

**Notes**

- You cannot perform Resume Play during Shuffle Play or Program Play.
- This function may not work properly with some discs.
- Resume Play is canceled when
  - you press  [12] when playback is stopped.
  - you open the disc tray.
  - you change the function.
  - you change the settings in the Setup Menu.
  - you changed the “PARENTAL CONTROL” level.

**Tip**

To play back from the beginning of the disc, press  [12] twice, then press  (or  on the unit) [12].

## Resuming playback of a disc that was stopped — Multi-disc Resume

(DVD VIDEO and VIDEO CD only)

This system can store the point where you stopped the playback of the disc for up to 10 discs and resumes playback when you insert the same disc again. If you store a playback resume point for the 11th disc, the playback resume point for the first disc will be deleted.

To activate this function, set “MULTI-DISC RESUME” in “SYSTEM SETUP” to “ON” (page 68).

### Notes

- If “MULTI-DISC RESUME” in “SYSTEM SETUP” is set to “ON” and you play back a recorded disc such as DVD-R, the system may play back other recorded discs from the same playback resume point. To start playback from the beginning of the disc, press **■** [12] twice and then press **▷** (or **◀▶** on the unit) [12].
- The playback resume point is deleted when the power cord is disconnected.

## Using play mode

### Creating your own program

#### — Program Play

VIDEO CD **C D**

You can make a program of up to 99 steps in the order you want them to be played back.

You can only program the tracks from the current disc.

- 1 Press **DISPLAY** [25] when playback is stopped.  
The Control Menu appears on the TV screen.
- 2 Press **↑** or **↓** [29] repeatedly to select **PROGRAM**, then press **ENTER** [6].  
The options for “PROGRAM” appear on the TV screen.
- 3 Press **↑** or **↓** [29] repeatedly to select “SET →,” then press **ENTER** [6].

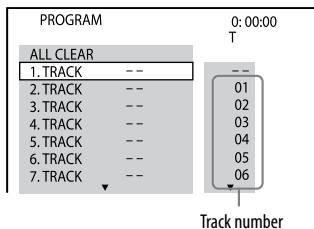

#### 4 Press $\blacktriangleright$ [29].

The cursor moves to the track list “T” (in this case, “01”).

PROGRAM		0:00:00
ALL CLEAR		T
1. TRACK	--	--
2. TRACK	--	01
3. TRACK	--	02
4. TRACK	--	03
5. TRACK	--	04
6. TRACK	--	05
7. TRACK	--	06

#### 5 Select the track you want to program.

For example, select track “02.”  
Press  $\blacktriangle$  or  $\blacktriangledown$  [29] repeatedly to select “02” under “T,” then press ENTER [6].

PROGRAM		0:03:51
ALL CLEAR		T
1. TRACK	02	--
2. TRACK	--	01
3. TRACK	--	02
4. TRACK	--	03
5. TRACK	--	04
6. TRACK	--	05
7. TRACK	--	06

Total time of the programmed tracks

#### 6 To program other tracks, repeat steps 4 to 5.

#### 7 Press $\blacktriangleright$ (or $\blacktriangleleft\blacktriangleright$ on the unit) [12].

Program Play starts.

When the Program Play ends, you can restart the same program by pressing  $\blacktriangleright$  (or  $\blacktriangleleft\blacktriangleright$  on the unit) [12].

##### To change a programmed step:

Press  $\blacktriangle$  or  $\blacktriangledown$  [29] repeatedly to select the programmed step number you want to change. Then, press  $\blacktriangleright$  [29] and select the desired track number.

##### To delete a programmed step:

Press  $\blacktriangle$  or  $\blacktriangledown$  [29] repeatedly to select the programmed step number you want to delete. Then, press CLEAR [31].



##### To delete all of the programmed steps in the program list:

Press  $\blacktriangle$  [29] to select “ALL CLEAR.” Then, press ENTER [6].

##### To cancel Program Play

Press CLEAR [31] or select “OFF” in step 3. To play back the same program again, select “ON” in step 3 and press ENTER [6].

## To turn off the Control Menu

Press  DISPLAY  repeatedly until the Control Menu disappears from the TV screen.

### Notes

- When Program Play is activated, the “REPEAT” setting is automatically changed to “ON” if the current setting is “ALL DISCS,” “ONE DISC” or “TRACK.”
- You cannot perform Program Play with VIDEO CDs during PBC playback.

### Tip

The Program Play is canceled and the program list is cleared when

- you open the disc tray.
- you change the disc.
- you turn off the system.
- you change the function.

## Playing in random order

### – Shuffle Play





VIDEO CD  DATA CD 

You can play back the tracks on the current disc in random order. Each time you perform Shuffle Play, the playing order may differ.



Shuffle Play is only available for the tracks on the current disc.

**1** Press  DISPLAY .

The Control Menu appears on the TV screen.

**2** Press  or   repeatedly to select  (SHUFFLE), then press ENTER .

The options for “SHUFFLE” appear on the TV screen.

**3** Press  or   repeatedly to select the setting you want.

### When playing a VIDEO CD or AUDIO CD:

- TRACK: all tracks on the current disc is played back randomly.



### When Program Play is activated:

- ON: all tracks in the program list is played back randomly.

### When playing a DATA CD/DVD (except for DivX video files):

- ON (MUSIC): all MP3 audio tracks in the selected folder on the current disc are played back randomly. When no folder is selected, the first folder is played back randomly.

4 Press ENTER [6].

5 Press  (or  on the unit) [12].

Shuffle Play starts.

To cancel Shuffle Play, press CLEAR [31] or select "OFF" in step 3.

### To turn off the Control Menu

Press  DISPLAY [25] repeatedly until the Control Menu disappears from the TV screen.

#### Notes

- Shuffle Play is canceled when
  - you open the disc tray.
  - you change the disc.
  - you turn off the system.
  - you change the function.
  - you perform Track/Index Search.
  - you set "MODE (MUSIC, IMAGE)" to "IMAGE" when playback is stopped.
  - you perform CD Synchro Recording.
  - you transfer music from a disc to an USB device.
- You cannot perform Shuffle Play with VIDEO CDs during PBC playback.
- The same song may be played back repeatedly for MP3 audio tracks.

## Playing repeatedly

### – Repeat Play





You can play the contents on a disc repeatedly.



You can select Shuffle Play and Program Play at the same time.

1 Press  DISPLAY [25].

The Control Menu appears on the TV screen.

2 Press  or  [29] repeatedly to select  (REPEAT), then press ENTER [6].

The options for "REPEAT" appear on the TV screen.

3 Press  or  [29] repeatedly to select the setting you want. The default setting is underlined.

### When playing a DVD VIDEO or DVD-R/DVD-RW in VR mode:

- OFF: does not play back repeatedly.
- ALL DISCS: repeats all discs.
- ONE DISC: repeats all the titles on the current disc.
- TITLE: repeats the current title.
- CHAPTER: repeats the current chapter.

### When playing a VIDEO CD or AUDIO CD:

- **OFF:** does not play back repeatedly.
- **ALL DISCS:** repeats all discs.
- **ONE DISC:** repeats all the tracks on the current disc.
- **TRACK:** repeats the current track.

### When playing a DATA CD or DATA DVD:

- **OFF:** does not play back repeatedly.
- **ALL DISCS:** repeats all discs.
- **ONE DISC:** repeats all the folders on the current disc.
- **FOLDER:** repeats the current folder.
- **TRACK<sup>1)</sup>:** repeats the current track.
- **FILE<sup>2)</sup>:** repeats the current file.

<sup>1)</sup> MP3 audio tracks only.

<sup>2)</sup> DivX video files only.

### When Program Play or Shuffle Play is activated:

- **OFF:** does not play back repeatedly.
- **ON:** repeats the Program Play or Shuffle Play.

**4** Press ENTER **[6]**.

**5** Press **[>]** (or **[◀▶]** on the unit) **[12]**.

Repeat Play starts.

To cancel Repeat Play, press CLEAR **[31]** or select "OFF" in step 3.

### To turn off the Control Menu

Press **[DISP]** DISPLAY **[25]** repeatedly until the Control Menu disappears from the TV screen.

### Notes

- You can also change the Repeat Play setting by pressing REPEAT/FM MODE **[20]** repeatedly.
- "REP" lights up in the display when Repeat Play is set to "ALL DISCS," "ONE DISC," "FOLDER" or "ON."
- "REPI" lights up in the display when Repeat Play is set to "TITLE," "CHAPTER," "TRACK" or "FILE."
- Depending on the DVD VIDEO, you cannot perform Repeat Play.
- You cannot perform Repeat Play with VIDEO CDs during PBC playback.
- When playing a DATA CD/DVD which contains MP3 audio tracks and JPEG image files, the audio sound will not match the image if their playing time are different.
- You cannot select "TRACK" when "MODE (MUSIC, IMAGE)" is set to "IMAGE" (page 55).
- Repeat Play is canceled when
  - you open the disc tray.
  - you change the disc (except when "ALL DISCS" is selected).
  - you turn off the system.
  - you change the function (except when "ALL DISCS" is selected).
  - you perform CD Synchro Recording.
  - you transfer music from a disc to an USB device.



## Searching/selecting a disc

### Playing DVD VIDEOS using the menu

#### DVD-V

Some DVD VIDEOS have menus to help you enjoy the DVD VIDEOS. You can play back DVD VIDEOS using these menus on the TV screen.

#### Using DVD TOP MENU

A DVD VIDEO contains a lot of sections of picture or music feature called "title." When you play back a DVD VIDEO which contains several titles, you can select the title you want using DVD TOP MENU [30].

#### Using DVD MENU

Some DVD VIDEOS allow you to select the disc contents using a menu. When you play back these DVD VIDEOS, you can select items such as the language for the subtitles and the language for the sound using DVD/TUNER MENU [24].

- 1 Press DVD TOP MENU [30] or DVD/TUNER MENU [24].  
The menu appears on the TV screen. The contents of the menu vary depending on the disc.
- 2 Press  $\uparrow/\downarrow/\leftarrow/\rightarrow$  [29] or the numeric buttons [32] to select the title or item you want to play back.
- 3 Press ENTER [6].

### Selecting "ORIGINAL" or "PLAY LIST" on a DVD-R/-RW in VR mode

#### DVD-VR

This function is only available for DVD-Rs/-RWs in VR mode with a playlist created.

- 1 Press  $\square$  DISPLAY [25] when playback is stopped.  
The Control Menu appears on the TV screen.

- 2 Press **▲** or **▼** [29] repeatedly to select **ORIGINAL/PLAY LIST**, then press **ENTER** [6].

The options for “ORIGINAL/PLAY LIST” appear on the TV screen.

- 3 Press **▲** or **▼** [29] repeatedly to select the setting you want.
  - **PLAY LIST**: play back according to the playlist created on the disc.
  - **ORIGINAL**: play back according to the originally recorded sequence.

- 4 Press **ENTER** [6].

### Using the on-screen display to search for a title/chapter/scene/track/index/folder/file



You can search by different information recorded on a disc, such as title, track, and folder. Each item is assigned a unique number on the disc, and you can select the numbered item you want from the Control Menu. You can also search for a particular point using the time code (Time Search) (DVD VIDEO and DVD-R/-RW in VR mode only).

- 1 Press **DISPLAY** [25]. When playing a DATA CD/DVD with JPEG image files, press **DISPLAY** [25] twice. The Control Menu appears on the TV screen.

- 2 Press **▲** or **▼** [29] repeatedly to select the search item.

Example: when you select **CHAPTER** (“\*\* (\*\*\*)” is selected (\*\* refers to a number). The number in parentheses indicates the total number of titles, chapters, tracks, indexes, scenes, folders or files.

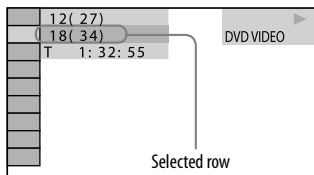

- 3 Press **ENTER** [6]. “\*\* (\*\*\*)” change to “- - (\*\*\*)”.

- 4** Press **↑** or **↓** **[29]** repeatedly or the numeric buttons **[32]** to select the title, track, folder or file, etc.  
If you make a mistake, press CLEAR **[31]** to cancel the number.
- 5** Press ENTER **[6]**.  
The system starts playback from the selected title, track, folder or file, etc.

### To turn off the Control Menu

Press **[DISP]** **[25]** repeatedly until the Control Menu disappears.

#### Tip

When the Control Menu display is turned off, you can search for a chapter (DVD VIDEO and DVD-R/-RW in VR mode) or track (AUDIO CD and VIDEO CD) or file (DivX video files in DATA CD/DVD) by pressing the numeric buttons **[32]** and ENTER **[6]**.

### To search for a particular point using the time code — Time Search

(DVD VIDEO and DVD-R/-RW in VR mode only)

- Press **[DISP]** **[25]**.
- Press **↑** or **↓** **[29]** repeatedly to select **[TIME]**.  
“T \*\*: \*\*: \*\*” (elapsed playing time of the current title) is selected.
- Press ENTER **[6]**.  
“T \*\*: \*\*: \*\*” changes to “T--:--:--”.
- Input the time code using the numeric buttons **[32]**, then press ENTER **[6]**.  
For example, to find the scene at 2 hours, 10 minutes, and 20 seconds after the beginning, enter “21020”.  
If you make a mistake, press CLEAR **[31]** to cancel the number.

#### Note

Depending on the disc, you cannot perform Time Search.

# Playing MP3/JPEG discs

DATA CD DATA DVD

## Notes

- The system can recognize up to 200 folders, and will not play any folders beyond the 200th. (Depending on the folder configuration, the number of folders that can be recognized by the system may decrease.)
- The maximum number of MP3 audio tracks or JPEG image files on a folder which this system can recognize is 150.
- The system can play back MP3 audio tracks and JPEG image files. The system will play back any data with the extension “.mp3”, “.jpg” or “.jpeg” even if they are not in MP3 or JPEG format. Playing this data may generate a loud noise which could damage your speaker system.
- Depending on the encoding/writing software, recording device, or the recording media used to record an MP3 audio track, you may encounter problems such as cannot play back, sound interruptions and noise.
- The following discs/situations can increase the time it takes to start playback:
  - a disc recorded with a complicated tree structure.
  - a disc recorded in Multi Session.
  - a disc to which data can be added (non-finalized disc).
  - when the tracks or files in another folder have just been played back.
- Some CD-Rs/-RWs or DVD-Rs/-RWs/+Rs/+RWs cannot be played back on the system depending on the file format.

- The system can play back to a depth of 8 folders only.
- The system may not play certain types of JPEG image files (ex. a JPEG image file that is less than 8 (width) × 8 (height)).

## Selecting an MP3 audio track or folder

- 1 Load a disc on the disc tray [4]. “FOLDER LIST” appears on the TV screen. If “FOLDER LIST” does not appear, press DVD/TUNER MENU [24].

### FOLDER LIST

Let's Talk About Love (1985)  
1st Album (1986)  
In the Middle of Nowhere (1986)  
Ready for Romance (1986)  
In the Garden of Venus (1987)  
Romantic Warriors (1987)  
Back for Good (1988)  
Alone (1999)

- 2 Press  $\blacktriangle$  or  $\blacktriangledown$  [29] repeatedly to select a folder.

### Playing a folder:

Press  $\blacktriangleright$  (or  $\blacktriangleleft$  on the unit) [12]. The system starts playback from the first track of the selected folder. To stop playback, press  $\blacksquare$  [12].

**Playing a track:**

- 1 Press ENTER [6].  
“TRACK LIST” appears.



- 2 Press  $\uparrow$  or  $\downarrow$  [29] repeatedly to select the MP3 audio track you want, then press ENTER [6].  
The system starts playing the selected MP3 audio track.  
To stop playback, press ■ [12].

**To display the next or previous page of “TRACK LIST” or “FOLDER LIST”**

Press  $\leftarrow$  or  $\rightarrow$  [27] repeatedly when “TRACK LIST” or “FOLDER LIST” is displayed.

**To play back the next folder of MP3 audio tracks**

You can select the next folder by pressing  $\blacktriangleright$  [12] repeatedly until the last track of the current folder, then press  $\blacktriangleright$  [12] once. The first track of the next folder is selected. However, you cannot select the previous folder by pressing  $\blacktriangleleft$  [12] repeatedly. To select the previous folder, select the folder from “FOLDER LIST.”

**To return to “FOLDER LIST” when “TRACK LIST” is displayed**

Press  $\hookrightarrow$  RETURN [28].

**To turn on or off “FOLDER LIST” or “TRACK LIST”**

Press DVD/TUNER MENU [24] repeatedly.

**Selecting a JPEG image file or folder**

- 1 Load a disc on the disc tray [4].  
“FOLDER LIST” appears on the TV screen.  
If “FOLDER LIST” does not appear, press DVD/TUNER MENU [24].
- 2 Press  $\uparrow$  or  $\downarrow$  [29] repeatedly to select a folder.

**Playing a folder:**

Press  $\triangleright$  (or  $\blacktriangleleft$  on the unit) [12].  
The system starts a slide show from the first image file of the selected folder.

Continued

### Playing an image file:

#### 1 Press PICTURE NAVI [19].

Thumbnail picture for the first 16 JPEG image files in the selected folder is displayed.

1	2	3	4
5	6	7	8
9	10	11	12
13	14	15	16

If there are more than 16 image files in the selected folder, the scroll bar appears at the right.

#### 2 Press $\uparrow/\downarrow/\leftarrow/\rightarrow$ [29] to select the image you want to view, then press $\triangleright$ (or $\blacktriangleleft$ on the unit) [12].

The slide show starts from the selected image file.

To stop playback, press  $\blacksquare$  [12].

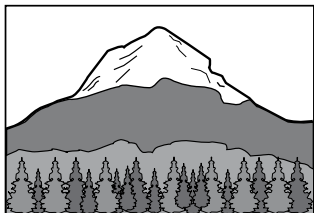

### To display the next or previous page of "FOLDER LIST"

Press  $\leftarrow$  or  $\rightarrow$  [27] repeatedly when "FOLDER LIST" is displayed.

### To display the next or previous JPEG image file

Press  $\leftarrow$  or  $\rightarrow$  [29] repeatedly during the slide show.

### To play back the next folder of JPEG image files

You can select the next folder by pressing  $\rightarrow$  [29] repeatedly until the last file of the current folder, then press  $\rightarrow$  [29] once. The first file of the next folder is selected. However, you cannot select the previous folder by pressing  $\leftarrow$  [29] repeatedly. To select the previous folder, select the folder from "FOLDER LIST."

### To turn on or off "FOLDER LIST"

Press DVD/TUNER MENU [24] repeatedly.

### To rotate a JPEG image file

When a JPEG image file is displayed on the TV screen, you can rotate the image by 90 degrees.

Press  $\uparrow$  or  $\downarrow$  [29] repeatedly while viewing an image.

Press CLEAR [31] to return to the original view.

## Notes

- The PICTURE NAVI **[19]** button does not work when “MODE (MUSIC, IMAGE)” is set to “MUSIC.”
- When you press **◀** or **▶** **[29]** to select the next or previous image, the image will return to its original view even if you have rotated the image previously.
- The slide show stops when you press **▲** or **▼** **[29]**.

## Playing MP3 audio tracks and JPEG image files as a slide show with sound

**DATA CD** **DATA DVD**

You can play back a slide show with sound by first placing both JPEG image files and MP3 audio tracks in the same folder on a DATA CD/DVD.

- 1 Load a disc on the disc tray **[4]**.
- 2 Press **☺** DISPLAY **[25]** when playback is stopped.  
The Control Menu appears on the TV screen.
- 3 Press **▲** or **▼** **[29]** repeatedly to select **🎵➡🖼️** (MODE (MUSIC, IMAGE)), then press ENTER **[6]**.  
The options for “MODE (MUSIC, IMAGE)” appear on the TV screen. The default setting is underlined.
  - AUTO: Plays back both JPEG image files and MP3 audio tracks in the same folder as a slide show with sound.
  - MUSIC: Plays back MP3 audio tracks continuously.
  - IMAGE: Plays back JPEG image files as a slide show.
- 4 Press **▲** or **▼** **[29]** repeatedly to select “AUTO,” then press ENTER **[6]**.
- 5 Press DVD/TUNER MENU **[24]**.  
“FOLDER LIST” appears on the TV screen.
- 6 Press **▲** or **▼** **[29]** repeatedly to select the folder you want, then press **▶** (or **◀▶▶** on the unit) **[12]**.  
The slide show with sound starts from the selected folder.  
To stop playback, press **■** **[12]**.

Continued 

### To turn on or off "FOLDER LIST"

Press DVD/TUNER MENU **[24]** repeatedly.

### To cancel slide show with sound

Select "MUSIC" or "IMAGE" in step 4.

#### Notes

- If there are no MP3 audio tracks in the disc and "MODE (MUSIC, IMAGE)" is set to "MUSIC," "No audio data" appears on the TV screen and the disc cannot be played back.
- If there are no JPEG image files in the disc and "MODE (MUSIC, IMAGE)" is set to "IMAGE," "No image data" appears on the TV screen and the disc cannot be played back.
- If you play back a large data size of MP3 audio tracks and JPEG image files at the same time, the sound may skip.

### Specifying the slide show speed

(JPEG image files only)

- 1 Press **[ ]** DISPLAY **[25]** repeatedly until the Control Menu for JPEG image files appears on the TV screen.
- 2 Press **[ ]** or **[ ]** **[29]** repeatedly to select **[ ]** (INTERVAL), then press ENTER **[6]**.  
The options for "INTERVAL" appear on the TV screen.

- 3 Press **[ ]** or **[ ]** **[29]** repeatedly to select the transition interval you want. The default setting is underlined.

- **NORMAL**: Sets to the standard duration.
- **FAST**: Sets the duration shorter than "NORMAL."
- **SLOW 1**: Sets the duration longer than "NORMAL."
- **SLOW 2**: Sets the duration longer than "SLOW 1."

- 4 Press ENTER **[6]**.

The selected setting takes effect.

#### Note

Some JPEG image files (especially progressive JPEG image files or JPEG image files with 3,000,000 pixels or more) may take a longer time to display than others, which may make the transitions seem longer than that of the option you selected.

### Selecting a transition effect for image files in the slide show

(JPEG image files only)

- 1 Press **[ ]** DISPLAY **[25]** repeatedly until the Control Menu for JPEG image files appears on the TV screen.



- 2 Press **↑** or **↓** **[29]** repeatedly to select **[EFFECT]** (EFFECT), then press **ENTER** **[6]**.  
The options for “EFFECT” appear on the TV screen.
- 3 Press **↑** or **↓** **[29]** repeatedly to select the setting you want.  
The default setting is underlined.
  - MODE 1: The image sweeps in from top to bottom of the screen.
  - MODE 2: The image sweeps in from left to right of the screen.
  - MODE 3: The image stretches out from the center of the screen.
  - MODE 4: The image randomly cycles through the effects.
  - MODE 5: The next image slides over the current image.
  - OFF: Turns off this function.
- 4 Press **ENTER** **[6]**.  
The selected setting takes effect.

## Enjoying DivX® video files

DATA CD DATA DVD

### About DivX Video Files

DivX® is a video file compression technology, developed by DivX, Inc. This product is an official DivX® Certified product.

This system can play back files which have the extension “.avi” or “.divx” that contain data in DivX format.

#### Notes

- The system may not play back a DivX video file when the file has been combined from two or more DivX video files.
- The system cannot play back a DivX video file size of more than 720 (width) × 576 (height)/2GB.
- Depending on the DivX video file, the picture may be unclear or the sound may skip.
- The system cannot play back some DivX video files that are longer than 3 hours.

Continued 

## Selecting a DivX video file or folder

- 1 Load a DATA CD/DVD with DivX video files on the disc tray [4].  
“FOLDER LIST” appears on the TV screen.  
If “FOLDER LIST” does not appear, press DVD/TUNER MENU [24].

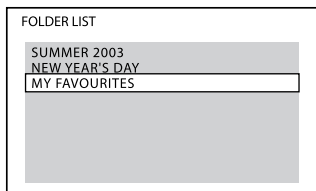

- 2 Press  $\uparrow$  or  $\downarrow$  [29] repeatedly to select a folder.

### Playing a folder:

Press  $\triangleright$  (or  $\blacktriangleleft\blacktriangleright$  on the unit) [12].

The system starts playing the first DivX video file of the selected folder.

To stop playback, press  $\blacksquare$  [12].

### Playing a DivX video file:

- 1 Press ENTER [6].  
“FILE LIST” appears.

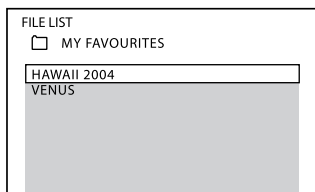

- 2 Press  $\uparrow$  or  $\downarrow$  [29] repeatedly to select the DivX video file you want, then press ENTER [6].  
The system starts playing the selected of DivX video files.  
To stop playback, press  $\blacksquare$  [12].

### To display the next or previous page of “FILE LIST” or “FOLDER LIST”

Press  $\leftarrow$  or  $\rightarrow$  [27] repeatedly when “FILE LIST” or “FOLDER LIST” is displayed.

### To play back the next folder of DivX video files

You can select the next folder by pressing  $\blacktriangleright\blacktriangleright$  [12] repeatedly until the last file of the current folder, then press  $\blacktriangleright\blacktriangleright$  [12] once. The first file of the next folder is selected. However, you cannot select the previous folder by pressing  $\blacktriangleleft\blacktriangleleft$  [12] repeatedly. To select the previous folder, select the folder from “FOLDER LIST”.

## To return to "FOLDER LIST" when "FILE LIST" is displayed

Press RETURN [28].

## To turn on or off "FOLDER LIST" or "FILE LIST"

Press DVD/TUNER MENU [24] repeatedly.

### Notes

- Depending on the DivX video file, the picture may pause or be unclear. In this case, it is recommended that you create the file at a lower bit rate. If the sound is still noisy, MP3 is the recommended audio format. Note that, this system does not conform to WMA (Windows Media Audio)/AAC (Advanced Audio Coding) format.
- Due to the compression technology used for DivX video files, it may take some time after you press [12] for the picture to appear.
- Depending on the DivX video file, the sound may not match the pictures on the screen.
- The system can recognize up to 150 DivX video files in a single folder. A maximum of 200 folders can be recognized.

### Tip

If the number of viewing times has been preset, you can play back the DivX video files as many times as the preset number. The following occurrences are counted:

- when the system is turned off.
- when the disc is removed.
- when another DivX video file is played back.

## Adjusting the delay between the picture and sound

### — "A/V SYNC"

**DVD-V** **DVD-VR** **VIDEO CD** **DATA CD** **DATA DVD**

When the sound does not synchronize with the pictures on the screen, you can adjust the delay between the picture and sound.

"A/V SYNC" does not work for MP3 audio tracks and JPEG image files in DATA CD/DVD.

#### 1 Press DISPLAY [25].

The Control Menu appears on the TV screen.

#### 2 Press or [29] repeatedly to select (A/V SYNC), then press ENTER [6].

The options for "A/V SYNC" appear on the TV screen.

#### 3 Press or [29] repeatedly to select the setting you want.

The default setting is underlined.

- OFF: Does not adjust.
- ON: Adjusts the difference between picture and sound.

#### 4 Press ENTER [6].

### Note









Depending on the input stream, this function may not be effective.



## Restricting playback of the disc

### — PARENTAL CONTROL

#### DVD-V

You can limit the playback of some DVD VIDEOS according to a predetermined level such as the age of the users. When a limited scene is played back, that scene may be skipped or replaced with different scenes.

- 1 Press  DISPLAY [25] when playback is stopped.  
The Control Menu appears on the TV screen.
- 2 Press  or  [29] repeatedly to select  (SETUP), then press ENTER [6].  
The options for “SETUP” appear on the TV screen.
- 3 Press  or  [29] repeatedly to select “CUSTOM,” then press ENTER [6].  
The Setup Menu appears on the TV screen.
- 4 Press  or  [29] repeatedly to select “SYSTEM SETUP,” then press ENTER [6].

- 5 Press  or  [29] repeatedly to select “PARENTAL CONTROL,” then press ENTER [6].

#### If you have not registered a password:

The display for registering a new password appears on the TV screen.

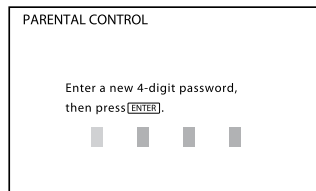

Enter a 4-digit password using the numeric buttons [32], then press ENTER [6].

The display for confirming the password appears on the TV screen.

#### When you have already registered a password:

The display for entering the password appears on the TV screen.

- 6** Enter or re-enter your 4-digit password using the numeric buttons **[32]**, then press ENTER **[6]**.

The display for setting the playback limitation level appears on the TV screen.

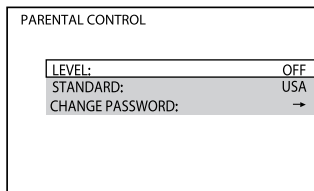

- 7** Press **▲** or **▼** **[29]** repeatedly to select “STANDARD,” then press ENTER **[6]**.

The options for “STANDARD” appear on the TV screen.

- 8** Press **▲** or **▼** **[29]** repeatedly to select a geographic area as the playback limitation level, then press ENTER **[6]**.

The area is selected.

When you select “OTHERS →,” enter the area code for the geographic area you want by using the numeric buttons **[32]** (see “Parental Control area code list” (page 144)).

- 9** Press **▲** or **▼** **[29]** repeatedly to select “LEVEL,” then press ENTER **[6]**.

The options for “LEVEL” appear on the TV screen.

- 10** Press **▲** or **▼** **[29]** repeatedly to select the level you want, then press ENTER **[6]**.

“PARENTAL CONTROL” setting is completed.

The lower the value, the stricter the limitation.

### If you make a mistake when entering your password

Press **◀** **[29]** repeatedly to delete the number you have entered, then re-enter your password again.

### To turn off the “PARENTAL CONTROL” function

Set “LEVEL” to “OFF” in step 10.

### To play back a disc for which “PARENTAL CONTROL” is set

- 1** Load the disc and press **▷** (or **◀▶** on the unit) **[12]**.

The display for entering your password appears on the TV screen.

- 2** Enter your 4-digit password using the numeric buttons **[32]**, then press ENTER **[6]**.

The system starts playback.

Continued

## Notes

- When you play back DVD VIDEOS which do not have the “PARENTAL CONTROL” function, playback cannot be limited on this system.
- Depending on the DVD VIDEO, you may be asked to change the “PARENTAL CONTROL” level while playing the disc. In this case, enter your password, then change the level. If Resume Play is canceled, the level returns to the original level.

## Tip

If you forget your password, remove the disc and repeat steps 1 to 5 of “Restricting playback of the disc” (page 60). When you are asked to enter your password, enter “199703” using the numeric buttons **[32]**, then press ENTER **[6]**. The display will ask you to enter a new 4-digit password. After you enter a new 4-digit password, reload the disc and press **[▷]** (or **[◀▶]** on the unit) **[12]**. When the display for entering your password appears, enter your new password.

## Changing the password

- 1** Press **[DISP]** DISPLAY **[25]** when playback is stopped.  
The Control Menu appears on the TV screen.
- 2** Press **[↑]** or **[↓]** **[29]** repeatedly to select **[SETUP]** (SETUP), then press ENTER **[6]**.  
The options for “SETUP” appear on the TV screen.

- 3** Press **[↑]** or **[↓]** **[29]** repeatedly to select “CUSTOM,” then press ENTER **[6]**.

The Setup Menu appears on the TV screen.

- 4** Press **[↑]** or **[↓]** **[29]** repeatedly to select “SYSTEM SETUP,” then press ENTER **[6]**.

- 5** Press **[↑]** or **[↓]** **[29]** repeatedly to select “PARENTAL CONTROL,” then press ENTER **[6]**.

The display for entering the password appears on the TV screen.

- 6** Enter your 4-digit password using the numeric buttons **[32]**, then press ENTER **[6]**.

- 7** Press **[↑]** or **[↓]** **[29]** repeatedly to select “CHANGE PASSWORD,” then press ENTER **[6]**.

- 8** Enter your 4-digit password using the numeric buttons **[32]**, then press ENTER **[6]**.

9 Enter a new 4-digit password using the numeric buttons [32], then press ENTER [6].

10 To confirm your password, re-enter it using the numeric buttons [32], then press ENTER [6].

### If you make a mistake when entering your password

Press ← [29] repeatedly to delete the number you have entered, then re-enter your password again.

## Using the Setup Menu

By using the Setup Menu, you can make various adjustments to items such as picture and sound.

Displayed items vary depending on the country or region.

### Note

Playback settings stored in the disc take priority over the Setup Menu settings. Therefore, some of the Setup Menu settings may not be performed.

1 Press  DISPLAY [25] when playback is stopped.  
The Control Menu appears on the TV screen.

2 Press ↑ or ↓ [29] repeatedly to select  (SETUP), then press ENTER [6].  
The options for "SETUP" appear on the TV screen.

3 Press ↑ or ↓ [29] repeatedly to select "CUSTOM," then press ENTER [6].  
The Setup Menu appears on the TV screen.

Continued 

- 4 Press **▲** or **▼** [29] repeatedly to select the setup item from the displayed list: “LANGUAGE SETUP,” “VIDEO SETUP,” “AUDIO SETUP,” “SYSTEM SETUP” or “SPEAKER SETUP.” Then press **ENTER** [6].

The setup item is selected.  
Example: “VIDEO SETUP”

Selected item

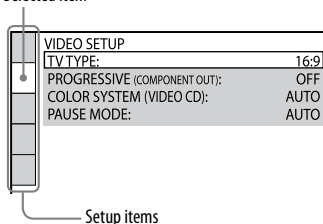

- 5 Press **▲** or **▼** [29] repeatedly to select the item you want, then press **ENTER** [6].

The options for the selected item appear on the TV screen.  
Example: “TV TYPE”

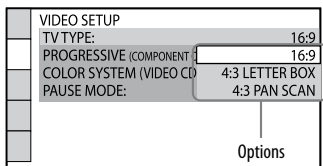

- 6 Press **▲** or **▼** [29] repeatedly to select the setting you want, then press **ENTER** [6].

The setting is selected and setup is completed.

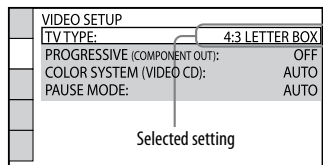

## Setup Menu item list

### Setting the language — “LANGUAGE SETUP”

Set various languages for the on-screen display or sound track.

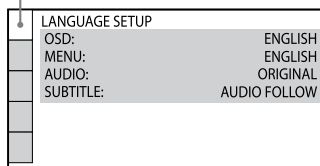



**OSD**

(On-Screen Display)

Switches the language of the on-screen display.

**MENU\***

(DVD VIDEO only)

Select the language for the DVD menu.

**AUDIO\***

(DVD VIDEO only)

Switches the language of the sound track.

When you select "ORIGINAL," the language given priority in the disc is selected.

**SUBTITLE\***

(DVD VIDEO only)

Switches the language of the subtitle. When you select "AUDIO FOLLOW," the language for the subtitles changes according to the language you selected for the sound track.

\* When you select a language in "MENU," "AUDIO," or "SUBTITLE" that is not recorded on the DVD VIDEO, one of the recorded language is automatically selected. However, depending on the disc, the language may not be selected automatically. If you select "OTHERS →" in "MENU," "AUDIO," and "SUBTITLE" enter a language code using the numeric buttons **32** (see "Language code list" (page 143)).

**Setting the TV screen — "VIDEO SETUP"**

Choose the settings according to the TV you connected.

The default setting is underlined.

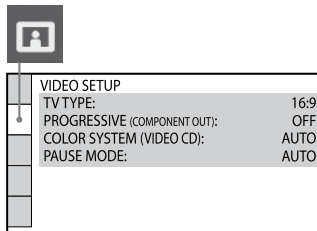
**TV TYPE<sup>1)</sup>**

(DVD VIDEO only)

**16:9:** Select this when you connect a wide-screen TV or a TV with a wide mode function.**4:3 LETTER BOX:** Select this when you connect a 4:3 screen TV. This setting displays a wide picture with bands on the upper and lower portions of the screen.Continued 

**4:3 PAN SCAN<sup>2)</sup>:** Select this when you connect a 4:3 screen TV. This setting displays the wide picture on the entire screen and cuts off the portions that do not fit.



---

### **PROGRESSIVE (COMPONENT OUT)**

Sets the progressive signal output from the COMPONENT VIDEO OUT jacks to on or off.

**OFF:** Outputs interlace signals.

**ON:** Outputs progressive signals.

For details, see “Changing the format of the video signal output from COMPONENT VIDEO OUT jacks” (page 28).

---

### **COLOR SYSTEM (VIDEO CD)**

(Except for Russian and Latin American models)

Select the output video signal when you play back a VIDEO CD.

**AUTO:** Outputs the video signal according to the color system of the disc, either PAL or NTSC.

**PAL:** Changes the video signal of an NTSC disc and output it in PAL system.

**NTSC:** Changes the video signal of a PAL disc and output it in NTSC system.

---

### **BLACK LEVEL**

(Latin American model only)

Selects the black level (setup level) for the video signals output from the jacks other than COMPONENT VIDEO OUT.

**ON:** Sets the black level of the output signal to the standard level.

**OFF:** Lowers the standard black level. Use this when the picture becomes too white.

---

### **BLACK LEVEL (COMPONENT OUT)**

(Latin American model only)

Selects the black level (setup level) for the video signals output from the COMPONENT VIDEO OUT jacks.

“BLACK LEVEL (COMPONENT OUT)” setting is not available when the system outputs progressive signal.

**OFF:** Raises the standard black level. Use this when the picture becomes too black.

**ON:** Sets the black level of the output signal to the standard level.

---

### **PAUSE MODE**

(DVD VIDEO and DVD-R/-RW in VR mode only)

**AUTO:** The picture, including subjects that move dynamically, is output with no jitter. Normally select this position.

**FRAME:** The picture, including subjects that do not move dynamically, is output in high resolution.

---

<sup>1)</sup> The default setting varies depending on the country or region.

<sup>2)</sup> Depending on the DVD VIDEO, “4:3 LETTER BOX” may be selected automatically instead of “4:3 PAN SCAN” or vice versa.

## Setting the audio options — “AUDIO SETUP”

Configure audio related settings.  
The default setting is underlined>.

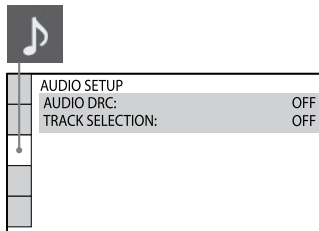

### AUDIO DRC<sup>1)</sup> (Dynamic Range Compression)

(DVD VIDEO only)

**OFF:** No compression of dynamic range.

**STANDARD:** Reproduces the sound track with the kind of dynamic range that the recording engineer intended. Useful for watching movies at low volume late at night.

**MAX:** Narrows the dynamic range fully.

### TRACK SELECTION

(DVD VIDEO only)

Gives priority to the sound track which contains the highest number of channels when you play back a DVD VIDEO on which multiple audio (PCM, DTS, MPEG audio, or Dolby Digital) formats<sup>2)</sup> are recorded.

**OFF:** No priority given.

**AUTO<sup>3)</sup>:** Priority given.

- <sup>1)</sup> “AUDIO DRC” can only be performed with Dolby Digital sources.
- <sup>2)</sup> If each audio sound track has the same number of channels, the system selects the audio sound tracks in the order from PCM, DTS, Dolby Digital, to MPEG.
- <sup>3)</sup> When you set “TRACK SELECTION” to “AUTO,” the language may change. The “TRACK SELECTION” setting has higher priority than the “AUDIO” settings in “LANGUAGE SETUP” (page 64). However, depending on the disc, this function may not be performed.

## Setting the system — “SYSTEM SETUP”

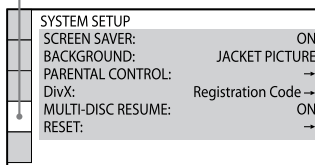

### SCREEN SAVER

The screen saver will help prevent your display device from becoming damaged (ghosting). Press any button (e.g., ) to cancel the screen saver.

**ON:** The screen saver image appears if you do not operate the system for about 15 minutes.

**OFF:** The screen saver does not appear.

---

## BACKGROUND

Selects the background color or picture to be displayed on the TV screen. The background color or picture is displayed when playback is stopped or while playing an AUDIO CD and MP3 audio tracks.

**JACKET PICTURE:** The jacket picture (still picture) appears in the background, but only when the jacket picture is already recorded on the disc (DVD VIDEO, CD-Extra, etc.). If the disc does not contain a jacket picture, the “GRAPHICS” picture appears.

**GRAPHICS:** A preset picture stored in the system appears in the background.

**BLUE:** The background color is blue.

**BLACK:** The background color is black.

---

## PARENTAL CONTROL

Sets the playback restrictions. For details, see “Restricting playback of the disc” (page 60).

---

## DivX

Displays the registration code for this system.

For more information, go to <http://www.divx.com> on the Internet.

---

---

## MULTI-DISC RESUME

(DVD VIDEO and VIDEO CD only)

**ON:** Stores the resume playback point in the memory for up to 10 discs.

**OFF:** Does not store the resume playback point in the memory. Playback starts at the resume playback point only for the current disc in the system.

---

## RESET\*

Returns “SETUP” settings to the default settings. For details, see “To return the “SETUP” settings to the default settings”, perform reset as follows.” (page 130).

---

\* Except for “PARENTAL CONTROL” settings

## Setting the speakers<sup>1)</sup> — “SPEAKER SETUP”

To obtain the best possible surround sound, set the connection of the speakers and their distance from your listening position. Then, use the test tone to adjust the level of the speakers to the same level. Setting items differ according to the model.

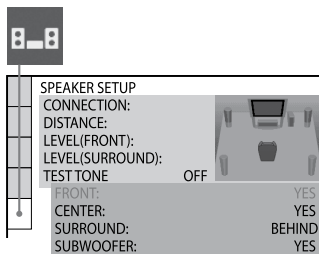

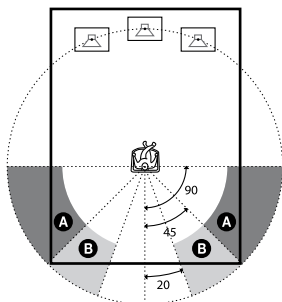
**CONNECTION****FRONT:** YES**CENTER (MHC-GZR9D/GZR8D only):**YES: Normally select this.NONE: Select this if the center speaker is not connected.**SURROUND (MHC-GZR9D/GZR8D only):**BEHIND: Select this if the surround speakers are located in section **B**.SIDE: Select this if the surround speakers are located in section **A**.NONE: Select this if the surround speakers are not connected.

Position diagram

**SUBWOOFER<sup>2)</sup>:**YES: Select this if you have connected the subwoofer.NONE: Select this if the subwoofer is not connected.**DISTANCE (MHC-GZR9D/GZR8D only)<sup>3)</sup>****FRONT 3.0 m<sup>4)</sup>:** Front speaker distance from the listening position can be set.**CENTER 3.0 m<sup>5)</sup>:** Center speaker distance from the listening position can be set.**SURROUND 3.0 m<sup>4)5)</sup>:** Surround speaker distance from the listening position can be set.**LEVEL (FRONT)<sup>6)</sup>**

For MHC-GZR9D/GZR8D, be sure to set "TEST TONE" to "ON" for easy adjustment.

**L 0.0 dB****R 0.0 dB****CENTER 2.0 dB (MHC-GZR9D/GZR8D only):****SUBWOOFER 3.0 dB (MHC-GZR9D), 0.0 dB (MHC-GZR8D/GZR7D):**

Depending on the subwoofer, the sound output may be smaller compared to other speakers when you adjust this level during the test tone.

**LEVEL (SURROUND) (MHC-GZR9D/GZR8D only)<sup>7)</sup>**

You can adjust the level of each surround speakers as follows. Be sure to set "TEST TONE" to "ON" for easy adjustment.

**L 0.0 dB****R 0.0 dB**

Continued

---

## TEST TONE (MHC-GZR9D/GZR8D only)

**OFF:** The test tone is not emitted from the speakers.

**ON:** The test tone is emitted from each speaker in sequence.

The test tone is emitted from the selected speakers when you select "LEVEL (FRONT)" or "LEVEL (SURROUND)."

- 1 Press **▲/▼/◀/▶** **[29]** repeatedly to select the desired speaker or the level.
- 2 Press **ENTER** **[6]**.
- 3 Repeat step 1 and 2. Press **▲/▼/◀/▶** **[29]** repeatedly to set "TEST TONE" to "OFF" when you have finished adjusting the speaker level.

- 
- 1) To return to the default setting when changing a setting, press **CLEAR** **[31]** before you press **ENTER** **[6]**. However, note that you cannot return the setting of "CONNECTION" to default setting. Note that you cannot perform "SPEAKER SETUP" when you connect headphones or microphones to the unit.
  - 2) Depending on the settings of other speakers, the subwoofer may output excessive sound.
  - 3) The items that are set to "NONE" in "CONNECTION" cannot be selected. When you perform "QUICK" setup (page 34), the default settings are changed.

- 4) If each left and right speakers are not placed at an equal distance from your listening position, set the distance according to the closest speaker.
- 5) The setting range changes depending on the front speaker setting.
- 6) The items that are set to "NONE" in "CONNECTION" cannot be selected.
- 7) This setting cannot be selected when "SURROUND" is set to "NONE" in the "CONNECTION" setting.

## Tuner

### Listening to the radio

You can listen to a radio station either by selecting a preset station, or by manually tuning in the station.

### Listening to a preset radio station

- 1 Press FUNCTION +/- [16] repeatedly to select "TUNER FM" or "TUNER AM" (or press TUNER/BAND [16] on the unit repeatedly to select "FM" or "AM").
- 2 Press and hold TUNING +/- [12] until the frequency indication changes and then release. "AUTO" flashes in the display. Scanning stops automatically when a station is tuned in and "TUNED" lights up in the display. When a FM stereo program is tuned in, "STEREO" lights up in the display.



If "TUNED" does not appear and the scanning does not stop, press TUNING +/- [12] repeatedly to tune in the station you want.

- 3 Press DVD/TUNER MENU [24]. "MEMORY?" flashes in the display.
- 4 Press ENTER [6] or → [29]. A preset number flashes in the display. The stations are stored from preset number 1.

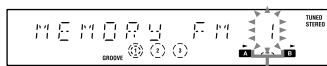

Preset number

- 5 Press ↑ or ↓ [29] repeatedly to select the preset number you want.
- 6 Press ENTER [6]. "COMPLETE" appears in the display. The station is stored.
- 7 Repeat steps 1 to 6 to store other stations. You can preset up to 20 FM stations and 10 AM stations. The preset stations are retained for half a day even if you unplug the power cord or if a power failure occurs.

- 8** To listen to a preset station, press PRESET +/- repeatedly (or turn OPERATION DIAL on the unit clockwise or counterclockwise) **[12]** to select the preset station you want. You can also press the numeric buttons **[32]**, then press ENTER **[6]** to select a preset station.

### To stop automatic scanning

Press **■ [12]**.

### To cancel presetting

Press DVD/TUNER MENU **[24]**.

## Listening to a non-preset radio station/station with a weak signal

- 1** Press FUNCTION +/- **[16]** repeatedly to select "TUNER FM" or "TUNER AM" (or press TUNER/BAND **[16]** on the unit repeatedly to select "FM" or "AM").

- 2** Tune in the station you want.

### For manual tuning:

Press TUNING +/- **[12]** repeatedly.

### For direct tuning:

Press D.TUNING **[22]**, then use the numeric buttons **[32]** to enter the frequency of the station you want. For example, press 1, 0, 2, 5 and 0 to enter the frequency of FM 102.50 MHz, then press ENTER **[6]**. If you cannot tune in the station, make sure you have entered the right frequency. If you still cannot tune in the station, the frequency is not used in your area.

### To cancel direct tuning

Press D.TUNING **[22]**.

### To change the AM tuning interval

(Except for Russian and Saudi Arabian models)

The AM tuning interval is factory-preset to 9 kHz or 10 kHz (for some areas).

- 1** Press FUNCTION +/- **[16]** repeatedly to select "TUNER AM" (or press TUNER/BAND **[16]** repeatedly to select "AM").
- 2** Press I/⏻ **[1]** to turn off the system.



- 3 Press DISPLAY **[2]** repeatedly until "SONY DEMO" appears in the display.
- 4 Press I/⏻ **[1]** on the unit while holding down TUNING + **[12]** on the unit.  
"AM 9K STEP" or "AM 10K STEP" appears in the display.  
When you change the interval, all the AM preset stations are erased.

### Tips

- To improve broadcast reception, adjust the supplied antennas, or connect an external antenna.
- When an FM stereo program has static noise, press REPEAT/FM MODE **[20]** repeatedly until "MONO" lights up in the display. There will be no stereo effect, but the reception will improve.
- You can also set the frequency by viewing the tuner information on the TV screen.

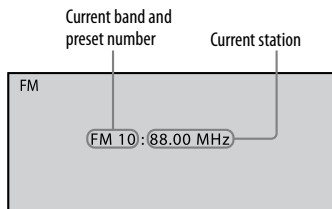

## Tape

### Playing a tape

You can use TYPE I (normal) tape.

- 1 Press FUNCTION +/- [16] (or TAPE A/B [16] on the unit) repeatedly to select "TAPE A" or "TAPE B."
- 2 Insert a tape.  
Press ▲ PUSH [11] on the unit to insert a tape into the cassette holder with the side you want to play back facing forward. Make sure there is no slack in the tape to avoid damaging the tape or the cassette holder.
- 3 Press OPTIONS [9] on the unit. "TIMER MENU" appears in the display.
- 4 Press ◀◀ or ▶▶ repeatedly (or turn OPERATION DIAL on the unit clockwise or counterclockwise) [12] until "DIRECTION" appears, then press ENTER [6].  
"CYCLE" appears in the display.

- 5 Press ◀◀ or ▶▶ repeatedly (or turn OPERATION DIAL on the unit clockwise or counterclockwise) [12] to select "1WAY" to play one side. Select "CYCLE"<sup>1)</sup> to play both sides or "RELAY"<sup>2)</sup> to play both decks in succession.

- 6 Press ENTER [6].

- 7 Press ▷ (or ◀▶ on the unit) [12].

The tape starts playing.  
To play the reverse side, press the button again<sup>3)</sup>.

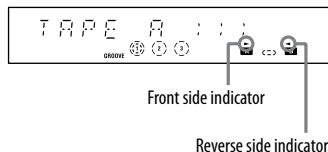

- 1) For the tape in deck B only.  
The playback stops automatically after repeating the sequence five times.
- 2) Relay Play follows this sequence:  
Deck A (front side) → Deck B (front side) → Deck B (reverse side)
- 3) For the tape in deck B only.

## Other operations

To	Do this
Stop playback	Press <b>■</b> <b>[12]</b> .
Pause playback	Press <b>⏸</b> <b>[12]</b> . Press <b>⏸</b> <b>[12]</b> again to resume playback.
Fast-forward or rewind	Press <b>⏩</b> or <b>⏪</b> <b>[12]</b> .

### Tip

If you press **▷** (or **◀▶** on the unit) **[12]** when “TAPE A” is selected and there is no tape in deck A, the system automatically switches to “TAPE B” when there is a tape in deck B or vice versa. Then, playback will start.

## Recording onto a tape

There are three ways to record on a TYPE I (normal) tape.

Use the buttons on the unit for the operation.

The recording level is adjusted automatically.

### CD Synchro Recording

You can record an entire VIDEO CD, AUDIO CD, or DATA CD/DVD (MP3 audio tracks only) onto a tape.

### Manual Recording

You can record just the portion you want from a sound source, including connected audio components.

### Sound Mixing

You can “mix” sound from any one of the sound sources and singing or speaking into a microphone. The mixed sound can be recorded onto a tape.

- 1 Insert a recordable tape into the deck B, then press TAPE A/B **[16]** repeatedly to select “TAPE B.”
- 2 Press OPTIONS **[9]**. “TIMER MENU” appears in the display.

Continued 

- 3** Turn OPERATION DIAL **[12]** clockwise or counterclockwise until “DIRECTION” appears, then press ENTER **[6]**.  
“CYCLE” appears in the display.

- 4** Turn OPERATION DIAL **[12]** clockwise or counterclockwise to select “1WAY” to record on one side. Select “RELAY” or “CYCLE” to record on both sides. Then, press ENTER **[6]**.

- 5** Press **◀▶ [12]** repeatedly to select recording side, then press **■ [12]**.

If you select both sides recording or front side recording, press **◀▶ [12]** repeatedly to light up the **▶** indicator, then press **■ [12]**. If you record on the reverse side, press **◀▶ [12]** repeatedly to light up the **◀** indicator, then press **■ [12]**.

- 6** Prepare the recording source.

**For CD Synchro Recording:**

Press DVD **[16]** and load the disc you want to record. If you have already loaded the disc, press DISC 1 — DISC 3 **[10]** to select the disc. When the system automatically starts playback, press **■ [12]** twice to cancel resume play.

**For Manual Recording and Sound Mixing:**

Select the desired source to record or mix.

If you record a disc manually, start playing the disc first, then perform steps 7 and 8. To record only your favorite CD tracks, perform steps 1 to 6 of “Creating your own program” (page 44).

To record only sound from a microphone, press USB **[16]** to select “USB,” and do not start playing the USB device in step 8.

- 7** Set the deck B to stand by for recording.

**For CD Synchro Recording:**

Press REC TO TAPE **[8]**.

If the play mode is set to Shuffle Play, Program Play or Repeat Play, it automatically switches to Normal Play.

**For Manual Recording and Sound Mixing:**

Press REC TO TAPE **[8]**.

- 8** Start recording.

**For CD Synchro Recording:**

Press ENTER **[6]**. When the recording is completed, the system stops automatically.

**For Manual Recording:**

Press ENTER **[6]**, and then start playing the desired recording source. If there is noise while recording from the tuner, reposition the appropriate antenna to reduce the noise.

**For Sound Mixing:**

Press ENTER [6], and then start playing the desired source and start singing or speaking into the microphone.

If acoustic feedback (howling) occurs, reduce the volume, move the microphone away from the speakers, or change the direction of the microphone.

**To stop recording**

Press ■ [12].

**Notes**

- CD Synchro Recording is not available with DVDs.
- You cannot listen to other sources while recording.
- When you press REC TO TAPE [8] in step 7, the surround effect may automatically change.
- When you record from a VIDEO CD, playback with PBC functions is automatically canceled (CD Synchro Recording only).
- When you press REC TO TAPE [8] or when you connect a microphone in “DVD” function, the following sound field is automatically selected.  
MHC-GZR9D/GZR8D
  - “LINK” if the headphones are not connected.
  - “HP 2CH” if the headphones are connected.
- MHC-GZR7D
  - “2CH STEREO” if the headphones are not connected.
  - “HP 2CH” if the headphones are connected.



- If you connect or disconnect a microphone or headphones during recording, the sound may cut off for a moment.
- When “DVD” function or “USB” function is selected, Karaoke Mode is automatically turned on when you connect a microphone to MIC jack [13].
- Do not eject the tape during recording, as this may cause irreparable damage to the tape and the tape deck.
- If you press REC TO TAPE [8] during Manual Recording or Sound Mixing, the recording is paused. To resume recording, press REC TO TAPE [8] again.
- The system may continue playback of other discs even after the Synchro Recording is completed.

**Tips**

- For VIDEO CD or AUDIO CD, if you select both sides recording and the tape reaches the end of the front side part-way through a track, the entire track is recorded again from the beginning of the reverse side (CD Synchro Recording only).
- When you record on both sides, be sure to start from the front side. If you start from the reverse side, recording stops at the end of the reverse side.
- When high level sound signals are input, the system automatically adjusts the recording level to prevent distortion of the recorded sound signal (Auto Level Control function).

## USB Device

### Transferring music from a disc to an USB device

You can connect an optional USB device to the  (USB) port  on the unit and transfer music from a disc to the USB device.

You can transfer music from an AUDIO CD or DATA CD/DVD (MP3 audio tracks only) only.

The audio format of files transferred by this system is MP3.

The amount of free space required on the USB device is about 1 MB per minute when transferring music from an AUDIO CD.

Required free space may be larger when transferring music from a DATA CD/DVD (MP3 audio tracks only).

Refer to “Compatible USB devices” (supplement) for a list of USB devices that can be connected to this system.



The transferred music is limited to private use only. Use of the music beyond this limit requires permission of the copyright holders.

#### Note on the maximum number of tracks, files and folders on an USB device

This system cannot transfer music from a disc in the following cases.

- When the number of tracks or files on a folder exceeds 150.
- When the number of folders on an USB device exceeds 200.

These numbers may vary depending on the track structure, the file structure and the folder structure.

- 1 Connect an USB device to the  (USB) port  as shown below.

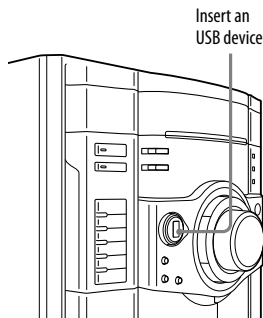

When USB cable connection is necessary, connect the USB cable supplied with the USB device to be connected.

See the operating instructions supplied with the USB device to be connected for details on the operation method.

When the USB device is connected, “READING” appears and “USB MEMORY” lights up in the display.

**Notes**

- Do not use the USB devices other than those listed in “Compatible USB devices” (supplement). Operation of models not listed is not guaranteed.
- Operation is not guaranteed, even when using these USB devices.
- When inserting the USB device, make sure of the direction and insert it all the way to the  (USB) port **[17]** on the unit.
- Do not forcibly insert the USB device, as this may cause the device to be damaged.
- Do not insert other device or objects besides the USB device.
- It may take about 10 seconds before “READING” appears in the display depending on the type of USB device connected.

**2** Press FUNCTION +/- **[16]** repeatedly to select “DVD” (or press DVD **[16]** on the unit).

**3** Load the disc you want to transfer.

If you have loaded the disc, press DISC SKIP repeatedly (or DISC 1 – DISC 3 on the unit) **[10]** to select the disc. When the system automatically starts playback, press **[12]** twice to cancel resume play.

**To remove the USB device**

- 1** Press **[12]** to stop playback.
- 2** Press I/⏻ **[1]** to turn off the system.
- 3** Remove the USB device.

**Using the front panel display**

You can easily transfer all the music on a disc to an USB device (Synchronized transfer).

You can also transfer a single audio track during playback (REC 1).

**1** Set the USB device to stand by for transferring.

**Synchronized transfer:**

Press **[12]** twice to cancel resume play, then press REC TO USB **[8]** on the unit.

**REC 1:**

Start playing the track you want to transfer, then press REC TO USB **[8]** on the unit.

“READING” appears, and the display cycles between “xxxMB FREE” (remaining space on the USB device) and “PUSH ENTER.”

The USB device stands by for transferring.

**2** Press ENTER **[6]**.

“USB,” “REC” and “SYNC” light up and transferring starts. No sound is output during transfer.

When the transfer is completed, the system stops automatically.

Continued 

## Using the on-screen display

- 1 Press **DISPLAY** when playback is stopped. The Control Menu appears on the TV screen.
- 2 Press **↑** or **↓** repeatedly to select **(USB RECORDING)**, then press **ENTER**.
- 3 Press **↑** or **↓** repeatedly to select the desired option, then press **ENTER**.

### For AUDIO CD:

- TRACK: The tracks on the AUDIO CD appear. You can transfer the desired track.

### For DATA CD/DVD:

- TRACK: The folders on the DATA CD/DVD appear. You can transfer the desired MP3 audio track.
- FOLDER: The folders on the DATA CD/DVD appear. You can transfer all MP3 audio tracks in the folder.

“Reading.” appears, and the tracks or folders appear on the TV screen.

### Note

It may take some time to display the tracks or folders depending on the number of tracks or folders.

- 4 Select the tracks that you want to transfer.

### For AUDIO CD:

Press **↑** or **↓** repeatedly to select the track, then press **ENTER**. The tracks are marked in the order that you select. To cancel the selection, press **ENTER** again.

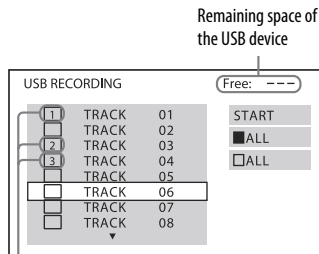

Tracks to be transferred

### To select all tracks on the AUDIO CD

Press **↑/↓/←/→** repeatedly to select “**ALL**,” then press **ENTER**. To cancel the selection, select “**ALL**,” then press **ENTER**.



### For DATA CD/DVD:

Press **▲** or **▼** **[29]** repeatedly to select the MP3 audio tracks or folders, then press ENTER **[6]**.

The MP3 audio tracks or folders are marked. To cancel the selection, press ENTER **[6]** again.

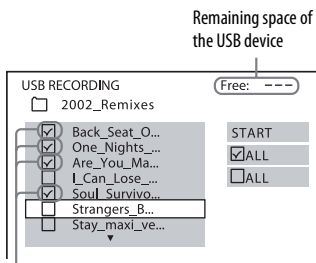

MP3 audio tracks or folders to be transferred

### To select all tracks or folders on the DATA CD/DVD

Press **▲/▼/◀/▶** **[29]** repeatedly to select **[✓] ALL**, then press ENTER **[6]**. To cancel the selection, select **[ ] ALL**, then press ENTER **[6]**.

- 5** Press **▲/▼/◀/▶** **[29]** repeatedly to select **START**, then press ENTER **[6]**.

The system starts transferring and the transfer status appears. No sound is output during transfer.

To stop transferring, press **■** **[12]**.

### To return to the previous display

Press **↶** RETURN **[28]**.

### To erase audio tracks or folders from the USB device

You can erase audio tracks or folders on the USB device.

- 1** Press FUNCTION **+/-** **[16]** repeatedly to select **USB** (or press USB **[16]** on the unit). **FOLDER LIST** appears.

- 2** Press **▲** or **▼** **[29]** repeatedly to select a folder.

To erase all audio tracks in a folder, press CLEAR **[31]**.

To erase an audio track, press ENTER **[6]**. **TRACK LIST** appears.

Press **▲** or **▼** **[29]** repeatedly to select the desired audio track, then press CLEAR **[31]**.

- 3** Press **◀** or **▶** **[29]** repeatedly to select **YES**, then press ENTER **[6]**. To cancel, select **NO**, then press ENTER **[6]**.

## Folder and track generation rules

When first transferring music to an USB device, a “MUSIC” folder is created directly below the “ROOT.” Folders and tracks are generated within this “MUSIC” folder as follows:

### ■ When transferring music from an AUDIO CD

In stop mode<sup>1)</sup>:

Folder name: “FLDR001”<sup>2)</sup>

Track name: “TRACK001”<sup>2)</sup>

During playback:

Folder name: “REC1-CD”<sup>3)</sup>

Track name: “TRACK001”<sup>2)</sup>

### ■ When transferring music from a DATA CD/DVD (MP3 audio tracks only)

In stop mode<sup>1)</sup>:

Folder name: Same as the transferred folder<sup>4)</sup>

Track name: Same as the transferred track<sup>5)</sup>

During playback:

Folder name: “REC1-MP3”<sup>3)</sup>

Track name: Same as the transferred track<sup>5)</sup>

<sup>1)</sup> Except when resuming playback.

<sup>2)</sup> Folder and tracks numbers are assigned serially thereafter.

<sup>3)</sup> A new track is created in the “REC1-CD” or “REC1-MP3” folder each time a transfer is performed.

<sup>4)</sup> Up to 64 characters of the name are assigned.

<sup>5)</sup> Up to 60 characters of the name are assigned.

## Notes

- Do not remove the USB device during transfer or erase operations. Doing so may corrupt the data on the USB device or damage the USB device itself.
- Do not connect the system and the USB device through an USB hub.
- When transferring music from an AUDIO CD, the tracks are transferred as 128 kbps MP3 audio tracks. When transferring music from a DATA CD/DVD, MP3 audio tracks are transferred with the same bit rate as the original MP3 audio tracks.
- CD text information is not transferred in the created MP3 audio tracks.
- Transferring stops automatically if:
  - the USB device runs out of space during the transfer process.
  - the number of tracks and folders on the USB device reaches the limit for the number that the system can recognize.
- Up to 150 audio tracks can be contained on a single folder and up to 200 folders can be contained on a single USB device. The maximum number of audio tracks and folders may vary depending on the audio tracks and folder structure.
- If the folder to be erased contains non-MP3/WMA (Windows Media Audio)/AAC format audio tracks or sub folders, these are not erased.
- If a folder or audio track that you are trying to transfer already exists on the USB device with the same name, a sequential number is added after the name without overwriting the original folder or track.

## Recording analog audio to a USB device

You can record the sound from analog audio sources.

- 1 Connect an USB device to the  (USB) port **[17]**.
  - 2 Press **FUNCTION +/- [16]** repeatedly to select the desired source.
    - **TAPE A/B:** To record from this system's tape deck.<sup>1)2)3)</sup>
    - **TUNER FM/AM:** To record from this system's tuner.
    - **DMPORT:** To record from the optional DIGITAL MEDIA PORT adapter connected to the DMPORT.
    - **VIDEO/SAT:** To record from the optional component connected to the VIDEO SAT AUDIO IN L/R jacks.
- <sup>1)</sup> If the playback direction of the tape is set to "CYCLE," the system will record both sides of the tape five times. If you want to stop at one recording, be sure to set the playback direction of the tape to "RELAY" or "1WAY"
- <sup>2)</sup> Recording continues even though tape playback has ended.
- <sup>3)</sup> Recording stops after playing deck A even when the playback direction of the tape is set to "RELAY."

- 3 Press **REC TO USB [8]** on the unit. "PLEASE WAIT" appears and the display cycles between "xxxMB FREE" (remaining space on the USB device) and "PUSH ENTER." The USB device stands by for recording.
- 4 Start playing the desired source to record, then press **ENTER [6]**. "USB" and "REC" light up and recording starts. To stop recording, press **■ [12]**.

### To remove the USB device

- 1 Press **■ [12]** to stop playback.
- 2 Press **I/⏻ [1]** to turn off the system.
- 3 Remove the USB device.

### To mark track numbers

You can mark the track numbers during recording of any source. Press **REC TO USB [8]** on the unit during recording at the point you want to add a track mark. "NEW TRACK" appears and a track mark is added.

## Folder and track generation rules

When first recording the analog audio to an USB device, a "MUSIC" folder is created directly below the "ROOT." Folders and tracks are generated within this "MUSIC" folder as follows:

### ■ When recording from the tape deck

Folder name: "TAPE001"\*

Track name: "TRACK001"\*

### ■ When recording from the tuner

Folder name: "FM001"\* or "AM001"\*

Track name: "TRACK001"\*

### ■ When recording from the DMPORT

Folder name: "DMPORT001"\*

Track name: "TRACK001"\*

### ■ When recording from the VIDEO/ SAT AUDIO IN L/R jacks

Folder name: "VIDEO001"\* or

"SAT001"\*

Track name: "TRACK001"\*

\* Folder and track numbers are assigned serially thereafter.

## Notes

- Do not remove the USB device during recording operation. Doing so may corrupt the data on the USB device or damage the USB device itself.
- Do not connect the system and the USB device through an USB hub.
- Each time you press REC TO USB [8] on the unit during recording, the system pauses recording for a few seconds to add a new track mark. No sound is recorded during this time.
- The track numbers are automatically marked when you record more than 60 minutes.
- Recording stops automatically when:
  - you change the function.
  - you turn off the system.
  - the USB device runs out of space during the recording.
  - the number of audio tracks on the USB device reaches the limit for the number that the system can recognize.
- The sound is recorded as 128 kbps MP3 audio track.
- Up to 150 audio tracks can be contained on a single folder and up to 200 folders can be contained on a single USB device. The maximum number of audio tracks and folders may vary depending on the audio tracks and folder structure.

## Listening to music of an USB device

You can listen to music stored in the USB device. The audio formats that can be played back by this system are as follows: MP3\*/WMA\*/AAC\*

Refer to “Compatible USB devices” (supplement) for a list of USB devices that can be connected to this system.

\* Files with copyright protection (Digital Rights Management) cannot be played by this system.

### Note on the maximum number of tracks, files and folders on an USB device

This system cannot play an USB device in the following cases.

- When the number of tracks or files on a folder exceeds 150.
- When the number of folders on an USB device exceeds 200.

These numbers may vary depending on the track structure, the file structure and the folder structure.

**1** Press FUNCTION +/- **[16]** repeatedly to select “USB” (or press USB **[16]** on the unit).

**2** Connect an USB device to the  (USB) port **[17]**.

When USB cable connection is necessary, connect the USB cable supplied with the USB device to be connected.

See the operating instructions supplied with the USB device to be connected for details on the operation method.

When the USB device is connected, “READING” appears and “USB MEMORY” lights up in the display.

### Notes

- Do not use the USB devices other than those listed in “Compatible USB devices” (supplement). Operation of models not listed is not guaranteed.
- Operation is not guaranteed, even when using these USB devices.
- When inserting the USB device, make sure of the direction and insert it all the way to the  (USB) port **[17]** on the unit.
- Do not forcibly insert the USB device, as this may cause the device to be damaged.
- Do not insert other device or objects besides the USB device.
- It may take about 10 seconds before “READING” appears in the display depending on the type of USB device connected.

### To remove the USB device

- 1** Press  **[12]** to stop playback.
- 2** Press I/⏻ **[1]** to turn off the system.
- 3** Remove the USB device.

### Notes on the USB device

- The system can play back up to 200 folders, including folders that do not contain MP3 audio tracks and JPEG image files.
- The file formats that this system can play are as follows:
  - MP3: file extension “.mp3”
  - WMA: file extension “.wma”
  - AAC: file extension “.m4a”
  - JPEG: file extension “.jpg” or “.jpeg”
 The system will play back any data with the extension above even if they are not in MP3/WMA/AAC/JPEG format. Playing this data may generate a loud noise which could damage your speaker system.

Continued 

- The following USB devices/situations can increase the time it takes to start playback:
  - an USB device recorded with a complicated tree structure.
  - when the tracks or files in another folder have just been played back.
- Some USB devices cannot be played back on the system depending on the file format.
- The system can play back to a depth of 8 folders only.
- When the USB device is inserted, the system reads all the files on the USB device. If there are many folders or files on the USB device, it may take a long time to finish reading the USB device.
- Do not connect the system and the USB device through an USB hub.
- With some connected USB devices, after an operation is performed, there may be a delay before it is performed by this system.
- Resume Play is canceled when you turn off the system.
- This system does not necessarily support all the functions provided in a connected USB device.
- Tracks transferred by a device such as a computer may not be played back in the order in which they were recorded.
- The playback order for the system may differ from the playback order of the connected USB device.
- Always turn off the system before removing the USB device. Removing the USB device while the system is on may corrupt the data on the USB device.
- Do not save other types of files or unnecessary folders on an USB device that has audio tracks or JPEG image files.
- Folders that have no audio tracks or JPEG image files are skipped.
- The maximum number of audio tracks and folders that can be contained on a single USB device is 200 (including the "ROOT" and "MUSIC" folders).  
The maximum number of audio tracks and folders may vary depending on the file and folder structure.
- Compatibility with all encoding/writing softwares, recording devices, and recording media cannot be guaranteed. Incompatible USB device may produce noise or interrupted audio or may not play at all.

## Selecting an audio track or folder

- 1 Press DISPLAY **[25]** when playback is stopped.  
The Control Menu appears on the TV screen.
- 2 Press or **[29]** repeatedly to select (MODE (MUSIC, IMAGE)), then press ENTER **[6]**.  
The options for “MODE (MUSIC, IMAGE)” appear on the TV screen.
- 3 Press or **[29]** repeatedly to select “MUSIC,” then press ENTER **[6]**.
- 4 Press DVD/TUNER MENU **[24]**.  
“FOLDER LIST” appears on the TV screen.

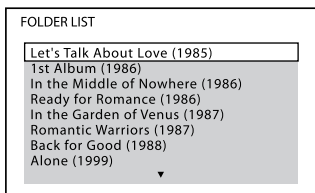

- 5 Press or **[29]** repeatedly to select a folder.

### Playing a folder:

Press (or on the unit) **[12]**.  
The system starts playback from the first track of the selected folder.  
To stop playback, press **[12]**.

### Playing a track:

- 1 Press ENTER **[6]**.  
“TRACK LIST” appears.



- 2 Press or **[29]** repeatedly to select the audio track you want, then press ENTER **[6]**.  
The system starts playing the selected audio track.  
To stop playback, press **[12]**.

### To display the next or previous page of “TRACK LIST” or “FOLDER LIST”

Press • **[27]** repeatedly when “TRACK LIST” or “FOLDER LIST” is displayed.

## To play back the next folder of audio tracks

You can select the next folder by pressing **▶▶▶** **[12]** repeatedly until the last track of the current folder, then press **▶▶▶** **[12]** once. The first track of the next folder is selected. However, you cannot select the previous folder by pressing **◀◀◀** **[12]** repeatedly. To select the previous folder, select the folder from “FOLDER LIST”

## To return to “FOLDER LIST” when “TRACK LIST” is displayed

Press **↶** RETURN **[20]**.

## To turn on or off “FOLDER LIST” or “TRACK LIST”

Press DVD/TUNER MENU **[24]** repeatedly.

## Selecting a JPEG image file or folder

- 1 Press **☰** DISPLAY **[25]** when playback is stopped.  
The Control Menu appears on the TV screen.

- 2 Press **▲** or **▼** **[29]** repeatedly to select **▶↶▶** (MODE (MUSIC, IMAGE)), then press ENTER **[6]**.  
The options for “MODE (MUSIC, IMAGE)” appear.
- 3 Press **▲** or **▼** **[29]** repeatedly to select “IMAGE,” then press ENTER **[6]**.
- 4 Press DVD/TUNER MENU **[24]**.  
“FOLDER LIST” appears on the TV screen.
- 5 Press **▲** or **▼** **[29]** repeatedly to select a folder.

### Playing a folder:

Press **▶** (or **◀▶▶** on the unit) **[12]**.  
The system starts a slide show from the first image file of the selected folder.



**Playing an image file:**

- 1 Press PICTURE NAVI [19].

Thumbnail picture for the first 16 JPEG image files in the selected folder is displayed.

1	2	3	4
5	6	7	8
9	10	11	12
13	14	15	16

If there are more than 16 image files in the selected folder, the scroll bar appears at the right.

- 2 Press  $\uparrow/\downarrow/\leftarrow/\rightarrow$  [29] to select the image you want to view, then press  $\triangleright$  (or  $\blacktriangleleft$  on the unit) [12].

The slide show starts from the selected image file.

To stop playback, press  $\blacksquare$  [12].

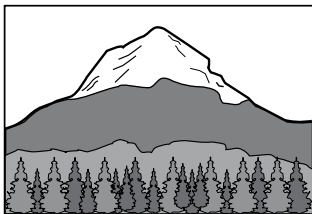
**To display the next or previous page of "FOLDER LIST"**

Press  $\leftarrow$  or  $\rightarrow$  [27] repeatedly when "FOLDER LIST" is displayed.

**To display the next or previous JPEG image file**

Press  $\leftarrow$  or  $\rightarrow$  [29] repeatedly during the slide show.

**To play back the next folder of JPEG image files**

You can select the next folder by pressing  $\rightarrow$  [29] repeatedly until the last file of the current folder, then press  $\rightarrow$  [29] once. The first file of the next folder is selected.

However, you cannot select the previous folder by pressing  $\leftarrow$  [29] repeatedly. To select the previous folder, select the folder from "FOLDER LIST"

**To turn on or off "FOLDER LIST"**

Press DVD/TUNER MENU [24] repeatedly.

**To rotate a JPEG image file**

When a JPEG image file is displayed on the TV screen, you can rotate the image by 90 degrees.

Press  $\uparrow$  or  $\downarrow$  [29] repeatedly while viewing an image.

Press CLEAR [31] to return to the original view.

## Notes

- The PICTURE NAVI **[19]** button does not work when “MODE (MUSIC, IMAGE)” is set to “MUSIC.”
- When you press **←** or **→** **[29]** to select the next or previous image, the image will return to its original view even if you have rotated the image previously.
- The slide show stops when you press **↑** or **↓** **[29]**.
- The maximum number of audio tracks or JPEG image files on a folder which this system can recognize is 150.
- If there are no audio tracks in the USB device and “MODE (MUSIC, IMAGE)” is set to “MUSIC,” “No audio data” appears on the TV screen and the USB device cannot be played back.
- If there are no JPEG image files in the USB device and “MODE (MUSIC, IMAGE)” is set to “IMAGE,” “No image data” appears on the TV screen and the USB device cannot be played back.

## Specifying the slide show speed

(JPEG image files only)









- 1 Press **DISPLAY** **[25]** repeatedly until the Control Menu for JPEG image files appears on the TV screen.
- 2 Press **↑** or **↓** **[29]** repeatedly to select  (INTERVAL), then press ENTER **[6]**.  
The options for “INTERVAL” appear on the TV screen.
- 3 Press **↑** or **↓** **[29]** repeatedly to select the transition interval you want. The default setting is underlined.
  - **NORMAL**: Sets to the standard duration.
  - **FAST**: Sets the duration shorter than “NORMAL.”
  - **SLOW 1**: Sets the duration longer than “NORMAL.”
  - **SLOW 2**: Sets the duration longer than “SLOW 1.”
- 4 Press ENTER **[6]**.  
The selected setting takes effect.

### Note



Some JPEG image files (especially progressive JPEG image files or JPEG image files with 3,000,000 pixels or more) may take a longer time to display than others, which may make the transitions seem longer than that of the option you selected.

## Selecting a transition effect for image files in the slide show

(JPEG image files only)

- 1 Press  DISPLAY  repeatedly until the Control Menu for JPEG image files appears on the TV screen.
- 2 Press  or   repeatedly to select  (EFFECT), then press ENTER  .

The options for “EFFECT” appear on the TV screen.

- 3 Press  or   repeatedly to select the setting you want.

The default setting is underlined.

  - MODE 1: The image sweeps in from top to bottom of the screen.
  - MODE 2: The image sweeps in from left to right of the screen.
  - MODE 3: The image stretches out from the center of the screen.
  - MODE 4: The image randomly cycles through the effects.
  - MODE 5: The next image slides over the current image.
  - OFF: Turns off this function.



- 4 Press ENTER .

The selected setting takes effect.





## Playing in random order

### — Shuffle Play



You can play back the tracks on the USB device in random order. Each time you perform Shuffle Play, the playing order may differ.

- 1 Press  DISPLAY .

The Control Menu appears on the TV screen.

- 2 Press  or   repeatedly to select  (SHUFFLE), then press ENTER .

The options for “SHUFFLE” appear on the TV screen.

- 3 Press  or   repeatedly to select the setting you want.



  - ON (MUSIC): all audio tracks in the selected folder on the USB device is played back randomly. When no folder is selected, the first folder is played back randomly.

- 4 Press ENTER .

Shuffle Play starts.  
To cancel Shuffle Play, press CLEAR  or select “OFF” in step 3.

Continued 

## To turn off the Control Menu

Press  DISPLAY  repeatedly until the Control Menu disappears from the TV screen.

### Notes

- Shuffle Play is canceled when:
  - you remove the USB device.
  - you turn off the system.
  - you change the function.
  - you set “MODE (MUSIC, IMAGE)” to “IMAGE” when playback is stopped.
- The same song may be played back repeatedly for audio tracks.





## Playing repeatedly

### – Repeat Play



You can play the audio tracks and JPEG image files on the USB device repeatedly. You can select Shuffle Play at the same time.

**1** Press  DISPLAY .

The Control Menu appears on the TV screen.

**2** Press  or   repeatedly to select  (REPEAT), then press ENTER .

The options for “REPEAT” appear on the TV screen.



**3** Press  or   repeatedly to select the setting you want.

- MEMORY: repeats all the folders on the USB device.
  - FOLDER: repeats the current folder.
  - TRACK\*: repeats the current track.
- \* Audio tracks only.

### When Shuffle Play is activated:

- ON: repeats the Shuffle Play.



4 Press ENTER .

5 Press  (or  on the unit) .

Repeat Play starts.

To cancel Repeat Play, press CLEAR  or select “OFF” in step 3.

### To turn off the Control Menu

Press  DISPLAY  repeatedly until the Control Menu disappears from the TV screen.

### Notes

- You can also change the Repeat Play setting by pressing REPEAT/FM MODE  repeatedly.
- “REP” lights up in the display when Repeat Play is set to “MEMORY,” “FOLDER” or “ON.”
- “REP1” lights up in the display when Repeat Play is set to “TRACK.”
- You cannot select “TRACK” when “MODE (MUSIC, IMAGE)” is set to “IMAGE” (page 88).
- Repeat Play is canceled when:
  - you remove the USB device.
  - you turn off the system.
  - you change the function.

## Sound Adjustment

### Adjusting the sound

#### Reinforcing the sound

You can reinforce the bass and create a more powerful sound.

Press GROOVE [7] on the unit repeatedly.

GROOVE ON\* → Z-GROOVE ON\* → GROOVE OFF → GROOVE ON → ...

\* The volume switches to power mode and the equalizer curve changes.

#### Tip

The default setting is "GROOVE ON."

### Selecting the preset effect

- 1 Press PRESET EQ [7] on the unit. The last selected preset effect appears in the display.
- 2 Press PRESET EQ [7] on the unit repeatedly to select the preset effect you want.

#### Preset effect options

Effect	Category
ROCK	Standard music sources
POP	
JAZZ	
DANCE	
SOUL	
TECHNO	
HIP HOP	
MP3 EQ	MP3 audio tracks
USER EQ 1, 2, 3	User equalizer setting (see "To adjust the graphic equalizer and store the user equalizer setting" (page 95))
FLAT	Original music source (cancels the preset effect)

#### Note

"EFFECT ON" appears when PRESET EQ [7] on the unit is pressed repeatedly while "GROOVE" or "Z-GROOVE" is turned on.

## To adjust the graphic equalizer and store the user equalizer setting

You can adjust the sound by raising or lowering the level of specific frequency band, then store up to three user equalizer setting, in the memory.

- 1 Press EQ BAND/MEMORY [7] on the unit repeatedly to select a frequency band.
- 2 Turn OPERATION DIAL [12] on the unit clockwise or counterclockwise to adjust the level.



- 3 Repeat steps 1 and 2 to adjust the level of other frequency bands.
- 4 Press ENTER [6] on the unit.  
A user equalizer number flashes in the display.

- 5 Turn OPERATION DIAL [12] on the unit clockwise or counterclockwise to select a user equalizer number (1 – 3) you want to store the equalizer setting. Select "EXIT" to cancel storing.
- 6 Press ENTER [6] on the unit.  
This setting is automatically stored as "USER EQ."  
The previous setting stored at this memory location is erased and replaced by the new setting.

## Selecting the sound field

You can take advantage of the surround sound simply by selecting one of the sound fields. They bring the exciting and powerful sound of movie theaters into your home.

- 1 Press SOUND FIELD [7].  
The last selected sound field appears in the display.

- 2 Press **▲/▼/◀/▶** **[29]** (or **SOUND FIELD [7]**) repeatedly when the last selected sound field appears in the display to select the sound field you want.

### **MHC-GZR9D/GZR8D:**

#### **When the headphones are not connected:**

---

#### **SBS MULTI<sup>1)2)</sup>** (Sound Broad System Multi mode)

Performs suitable decoding based on the source to maximize the sound field effect. This mode lets you enjoy audio playback of all types of discs from multiple speakers.

---

#### **A.F.D. AUTO<sup>2)</sup>** (Auto Format Direct Auto)

The number of sound channels depends on the source. During DVD function, when 2 channel sources such as AUDIO CD, VIDEO CD and MP3 audio tracks are played back, only 2 sound channels would be output. However, the number of sound channels output during DVD VIDEO and DivX video files playback would depend on the audio format selection. During other functions, the system would only output 2 sound channels. This setting is ideal when you want to listen to the original sound from the source.

---

#### **PRO LOGIC<sup>2)</sup>**

Performs Pro Logic decoding. The source recorded in 2 channels is decoded into 4.1 channels.

---

#### **PLII MOVIE<sup>2)</sup>**

Performs Pro Logic II Movie mode decoding. This setting is ideal for movies encoded in Dolby Surround. In addition, this mode can reproduce sound in 5.1 channels when watching videos of overdubbed or old movies. The source recorded in 2 channels is decoded into 5.1 channels.

---

#### **PLII MUSIC<sup>2)</sup>**

Performs Pro Logic II Music mode decoding. This setting is ideal for normal stereo sources such as AUDIO CDs. The source recorded in 2 channels is decoded into 5.1 channels.

---

#### **V.M.DIM.<sup>2)</sup>**

Performs DCS (Digital Cinema Sound) decoding. The source recorded in 2 channels is decoded into 5.1 channels.

---

#### **LINK**

Reproduces the surround channels from the front channels.



---

**2CH STEREO**

Reproduces stereo output from multi channel sources such as DVD VIDEOS during “DVD” function. The system outputs the original sound during functions other than “DVD” and during playback of stereo sources such as AUDIO CD, VIDEO CD and MP3 audio tracks.

---

**When the headphones are connected:**

---

**HP 2CH**

The normal sound field for headphones.

---

**HP VIRTUAL<sup>2)</sup>**

The sound field for headphones with virtual surround effect. This sound field is only effective when you play back multi channel sources.

---

<sup>1)</sup> When playing a DVD, the effect is the same as “A.F.D. AUTO.”

- <sup>2)</sup> These sound fields cannot be selected when:
- the system is in standby for tape recording or during tape recording.
  - a microphone is connected.
  - the Karaoke Mode is turned on.

---

**MHC-GZR7D:****When the headphones are not connected:**

---

**2CH STEREO**

Reproduces stereo output from multi channel sources such as DVD VIDEOS during “DVD” function. The system outputs the original sound during functions other than “DVD” and during playback of stereo sources such as AUDIO CD, VIDEO CD and MP3 audio tracks.

---

**VIRTUAL A\***

Creates 3 sets of virtual surround speakers from the sound of the front speakers. This sound field is only effective when you play back multi channel sources.

---

**VIRTUAL B\***

Creates 1 set of virtual surround speakers from the sound of the front speakers without using actual surround speakers. This mode is effective when the distance between the front speakers is short. This sound field is only effective when you play back multi channel sources.

---

## When the headphones are connected:

### HP 2CH

The normal sound field for headphones.

### HP VIRTUAL\*

The sound field for headphones with virtual surround effect. This sound field is only effective when you play back multi channel sources.

\* These sound fields cannot be selected when:

- the system is in standby for tape recording or during tape recording.
- a microphone is connected.
- the Karaoke Mode is turned on.

### Notes

- Depending on the disc, the surround effect may not be as much as expected.
- For MHC-GZR9D/GZR8D, if “NONE” is selected in surround speaker setup, no sound will be output from the surround speakers even if “LINK” is selected.
- You cannot change the sound field when transferring or recording to the USB device.

## Singing along: Karaoke



You can enjoy Karaoke by setting the system to Karaoke Mode.

### Preparing for karaoke

(DVD VIDEO, DVD-R/-RW in VR mode, VIDEO CD, MP3 audio tracks (including those on a USB device), and DivX video files only)

- 1 Press **FUNCTION +/-** **[16]** repeatedly to select “DVD” or “USB” (or press **DVD [16]** or **USB [16]** on the unit).
- 2 Turn **MIC LEVEL [13]** on the unit to “MIN” to reduce the microphone volume.
- 3 Connect a microphone to **MIC jack [13]** on the unit.  
The Karaoke Mode is turned on. “KARAOKE MODE: ON” appears on the TV screen and “” appears in the display.

- 4** Start playing the music and adjust the volume.

**DVD VIDEO, DVD-R/-RW in VR mode, DivX video files:**

The system outputs the audio format that you have selected.

**AUDIO CD, VIDEO CD, MP3 audio tracks:**

The audio setting automatically changes to “1/L” and the system outputs the left channel audio.

**If you want to hear vocal:**

Press AUDIO **[21]** repeatedly to select another audio channel.

- 5** Start singing along with the music and adjust the microphone volume by turning MIC LEVEL **[13]**.

**To turn off the Karaoke Mode**

Disconnect the microphone or press KARAOKE MODE **[33]**. “KARAOKE MODE: OFF” appears on the TV screen.

**Other operations**

To	Do this
Adjust the microphone volume	Turn MIC LEVEL <b>[13]</b> on the unit.
Adjust the microphone echo	Turn ECHO LEVEL <b>[13]</b> on the unit.
Cancel the echo effect	Turn ECHO LEVEL <b>[13]</b> on the unit to “MIN.”

**Notes**

- The sound input from the microphone is not output from the DVD DIGITAL OUT jack (MHC-GZR7D only).
- Karaoke Mode is automatically turned off when you:
  - turn off the system.
  - change the function (except for the “DVD” function or “USB” function).
  - connect the headphones.
- If howling occurs:
  - move the microphone away from the speakers.
  - change the direction of the microphone.
  - lower the MIC LEVEL **[13]** or ECHO LEVEL **[13]**.
  - press VOLUME — repeatedly (or turn MASTER VOLUME on the unit counterclockwise) **[15]**.

## “Dolby Digital Karaoke” format

(DVD VIDEO only)

The Dolby Digital format, which reproduces surround sound using 5 channels, can also contain the “Dolby Digital Karaoke” format which is specialized for karaoke. In the “Dolby Digital Karaoke” format discs, guide melody and guide vocal tracks are recorded in addition to the accompaniment. You can select them when Karaoke Mode is turned on.

### Speaker output in normal Dolby Digital format (5 channel)

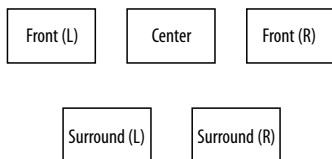

### Speaker output in “Dolby Digital Karaoke” format

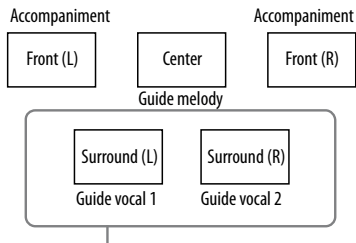

You can select any of these.

You can check the audio information by pressing AUDIO  (page 41). When playing a “Dolby Digital Karaoke” disc, “J” appears at the current audio format.

Example:

DOLBY DIGITAL   3 / 2

2/0: Recorded only with accompaniment.

3/0: Recorded with guide melody.

3/1: Recorded with guide melody and one guide vocal.

3/2: Recorded with guide melody and two guide vocals.

## Changing the key

### — Key Control

You can change the key to suit your vocal range, except when the system is in stop mode.

Press KEY CONTROL **b/#** **[33]** to suit your vocal range in Karaoke mode. You can adjust the key higher or lower in 13 steps (**b6** – **#6**).

#### Notes

- Depending on the disc, you may not be able to change the key.
- The key automatically returns to the original key when:
  - you turn off the system.
  - you change the function.
  - you change the disc.
  - the disc tray is opened.
  - you stop playback.
  - the title or track changes.
  - you change the folder.
  - the play item is changed during PBC playback.
  - you perform Lock Search.
  - you cancel Karaoke mode.
  - DVD layer is changed.

## Playing karaoke with any stereo disc

### — “Karaoke Pon”

You can enjoy karaoke with a stereo-recorded disc, even if it is a non-karaoke disc, by reducing the sound of the vocals.

Press KARAOKE PON **[33]** in Karaoke mode.

### To cancel “Karaoke Pon” mode

Press KARAOKE PON **[33]** again.

#### Notes

- This function may not work well when:
  - only a few instruments are playing.
  - a duet is playing.
  - the vocals on the disc deviate from the center.
  - playing monaural-recorded discs (the accompaniment is also reduced).
  - playing multiplex discs.
- During “Karaoke Pon” mode, the stereo effect is reduced.
- “Karaoke Pon” mode is automatically canceled when:
  - you turn off the system.
  - you change the function.
  - you change the disc.
  - you open the disc tray.
  - you press AUDIO **[21]**.
  - you set “VOCAL SELECT” to other than “OFF”.
  - you cancel Karaoke mode.

## Selecting the vocals

— Vocal Select (DVD VIDEO/  
VIDEO CD/CD only)





When playing a DVD with the “Dolby Digital Karaoke” format in Karaoke mode, you can turn on or off the guide vocal recorded in the karaoke track.

When playing a VIDEO CD or AUDIO CD in Karaoke mode, you can listen to the vocals.

You can also change the guide vocal channel. You can select different kinds of vocals.

**1** Press  DISPLAY  in Karaoke mode.

The Control Menu appears on the TV screen.

**2** Press  or   repeatedly to select  (VOCAL SELECT), then press ENTER .

The options for “VOCAL SELECT” appear on the TV screen.

**3** Press  or   repeatedly to select the desired vocal channel.

The output channel changes as follows.

The default setting is underlined.

### When playing a DVD VIDEO

- OFF: Turns off the guide vocal.
- 1+2: Guide vocal 1+2
- 1: Guide vocal 1
- 2: Guide vocal 2

### When playing a VIDEO CD or AUDIO CD

- OFF: Turns off the guide vocal.
- L+R: The same sound is output from both speakers.
- STEREO: The standard stereo sound

### When playing a Super VCD

- OFF: Turns off the guide vocal.
- 1:L+R: The same sound of the audio track 1 is output from both speakers.
- 1:STEREO: The stereo sound of the audio track 1
- 2:L+R: The same sound of the audio track 2 is output from both speakers.
- 2:STEREO: The stereo sound of the audio track 2

#### 4 Press ENTER [6].

##### Notes

- When playing a DVD VIDEO, the function works only with the “Dolby Digital Karaoke” format.
- Depending on the disc, you may not be able to change the guide vocal channel.
- The channel returns to the default setting when:
  - you turn off the system.
  - you change the function.
  - you change the disc.
  - you open the disc tray.
  - you press AUDIO [2].
  - you cancel Karaoke mode.
  - you set “Karaoke Pon” mode to on.
- When playing a DVD VIDEO recorded only with one kind of guide vocal, select “1.”

### Selecting the scoring mode

#### – Score Mode

When karaoke mode is turned on, you can use the scoring mode. Your score is calculated by comparing your voice with the music source.

#### 1 Press DISPLAY [25] in Karaoke mode.

The Control Menu appears on the TV screen.

#### 2 Press or [29] repeatedly to select (SCORE MODE), then press ENTER [6].

The options for “SCORE MODE” appear on the TV screen.

#### 3 Press or [29] repeatedly to select a setting.

The default setting is underlined.

- BEGINNER 1: Beginner level. The score updates every 3 seconds.
- BEGINNER 2: Beginner level.
- EXPERT 1: Advance level. The score updates every 3 seconds.
- EXPERT 2: Advance level.
- DEMO: Demonstration mode. The score is displayed regardless of singing.

#### 4 Press ENTER [6].

#### 5 Start playing the music.

#### 6 Press SCORE [33] before singing a song in Karaoke mode.

The previous highest score appears on the TV screen and the display changes as follows according to the level selected for “SCORE MODE.”

: When you select “BEGINNER 1” or “EXPERT 1.”

: When you select “BEGINNER 2” or “EXPERT 2.”

 DEMO: When you select “DEMO.”

Continued 

**7** After singing for more than a minute, press SCORE **33** again to view your score.

Your score is calculated from a scale of 0 to 99.

Your score is displayed for 5 seconds, during which time the system enters pause mode.

After your score, the ranking is displayed as follows:

- The ranking is displayed as a list with top 3 scores.
- Your score and ranking for the last song flash.
- If you are in the top 10, your ranking is displayed. If not, "10+" is displayed.
- If your score is "0," your score is not displayed in the ranking list.

#### **Notes**

- The highest score is reset when the system is turned off.
- The "SCORE MODE" function may be canceled when certain remote buttons are pressed.
- In some cases, you may not be able to use the scoring mode.

#### **Tip**

The "SCORE MODE" setting is automatically changed to "BEGINNER 1" when the system is turned off.



## Other Operations

### Using the timer

#### Falling asleep to music

##### — Sleep Timer

You can set the system to turn off after a certain time, so that you can fall asleep to music.

Press SLEEP **[35]** repeatedly to select the time you want.

#### Setting the timer

##### — Play Timer/Rec Timer

You cannot activate both the Play Timer and the Rec Timer at the same time. Make sure you have set the clock (see “Setting the clock” (page 33)).

##### **Play Timer**

You can wake up to music at a preset time.

##### **Rec Timer**

You can record from a preset radio station at a specified time.

## 1 Prepare the sound source.

### **For Play Timer:**

You can select one of the following music sources.

Disc: Load a disc.

USB: Connect an USB device.

Tape: Load a tape with the side you want to play facing forward.

Tuner: Tune in the preset station you want.

Then press VOLUME +/- (or turn MASTER VOLUME on the unit) **[15]** to adjust the volume.

### **For Rec Timer:**

Tune in the preset radio station you want.

## 2 Press TIMER MENU **[36]**.

## 3 Press **▲** or **▼** **[29]** repeatedly to select “PLAY SET” or “REC SET,” then press ENTER **[6]**. “ON” appears and the hour indication flashes in the display.

#### 4 Set the time to start playback or recording.

Press  $\blacktriangle$  or  $\blacktriangledown$  [29] repeatedly to set the hour, then press ENTER [6].

The minute indication flashes in the display. Use the procedure above to set the minute. "OFF" appears and the hour indication flashes in the display.

#### 5 Set the time to stop playback or recording using the same procedure as step 4.

#### 6 Select the sound source or prepare the tape or USB device.

##### For Play Timer:

Press  $\blacktriangle$  or  $\blacktriangledown$  [29] repeatedly until the music source (DVD, USB, tape or tuner) you want appears in the display, then press ENTER [6]. The display will show the timer settings.

##### For Rec Timer:

The display will show the timer settings.

When recording to a tape, perform steps 1 through 5 of "Recording onto a tape" (page 75).

When you record on both sides, be sure to start from the front side. If you start from the reverse side, recording stops at the end of reverse side.

When recording to an USB device, perform steps 1 and 2 of "Listening to music of an USB device" (page 85).

#### 7 Press I/⏻ [1] to turn off the system.

Be sure to turn off the system at least 120 seconds before the preset time.

### Other operations

To	Do this
Check the setting	<ol style="list-style-type: none"><li>1 Press TIMER MENU [36]. "TIMER SELECT" flashes in the display.</li><li>2 Press ENTER [6].</li><li>3 Press <math>\blacktriangle</math> or <math>\blacktriangledown</math> [29] repeatedly to select "PLAY SELECT" or "REC SELECT," then press ENTER [6].</li></ol>
Change the setting	Start from step 1.
Cancel the Play Timer or Rec Timer	<ol style="list-style-type: none"><li>1 Press TIMER MENU [36]. "TIMER SELECT" flashes in the display.</li><li>2 Press ENTER [6].</li><li>3 Press <math>\blacktriangle</math> or <math>\blacktriangledown</math> [29] repeatedly to select "TIMER OFF," then press ENTER [6].</li></ol>

## Notes

- If you use the Play Timer or Rec Timer and the Sleep Timer at the same time, the Sleep Timer has priority.
- The Play Timer and Rec Timer will not be activated if the system is turned on or if “STANDBY” flashes in the display.
- The volume is reduced to minimum during Rec Timer.
- When you set the Rec Timer, the system turns on 90 seconds before the preset time. When you set the Play Timer, the system turns on 30 seconds before the preset time. Do not operate the system from the time the system turns on until the play or recording starts.

## Tip

You can perform the timer settings by using OPTIONS [9], OPERATION DIAL [12] and ENTER [6] on the unit.

# Changing the display

## Turning off the display

### – Power Saving Mode

The demonstration display and the clock display can be turned off to minimize the amount of power consumed during standby mode (Power Saving Mode).

Press DISPLAY [2] repeatedly while the system is turned off.

Demonstration<sup>1)</sup> →

No display (Power Saving Mode) →

Clock<sup>2)</sup> → Demonstration → ...

<sup>1)</sup> The display changes and the indicators flash even when the system is turned off.

<sup>2)</sup> The clock display automatically turns to Power Saving Mode after 8 seconds.

## Note

You cannot perform the following operations during Power Saving Mode:

- Setting the clock (page 33).
- Changing the AM tuning interval (Except for Russian and Saudi Arabian models) (page 72).
- Changing the color system (Except for Russian and Latin American models) (page 27).

Continued 

## Changing the power illuminator

Press ILLUMINATION [2] on the unit repeatedly to change the illumination pattern around MASTER VOLUME [15] on the unit.

Each time you press the button, the display changes as follows:

PATTERN 1 → PATTERN 2 →  
PATTERN 3 → PATTERN OFF →  
PATTERN 1 → ...

## Viewing information about the disc

### Viewing information about the disc in the front panel display

Press DISPLAY [2].

Each time you press DISPLAY [2], the display changes from ① → ② → ③ → ① → ...

- ① Disc information
- ② Clock display (for 8 seconds)
- ③ Effect name (for 4 seconds)

### Checking the elapsed playing time, remaining time and titles

Press TIME/TEXT [34] during playback. Each time you press TIME/TEXT [34], the display changes from ① → ② → ... → ① → ...

#### When playing a DVD VIDEO or DVD-R/-RW in VR mode:

- When the menu or the title without a chapter is played back
  - ① Elapsed playing time of the menu or the current title
  - ② Disc title<sup>1)</sup>

- When a chapter other than above condition is played back
  - ① Elapsed playing time of the current title
  - ② Remaining time of the current title
  - ③ Elapsed playing time of the current chapter
  - ④ Remaining time of the current chapter
  - ⑤ Disc title<sup>1)2)</sup>

#### When playing an AUDIO CD or VIDEO CD without PBC function:

- ① Elapsed playing time of the current track
- ② Remaining time of the current track
- ③ Elapsed playing time of the disc<sup>3)</sup>
- ④ Remaining time of the disc<sup>3)</sup>
- ⑤ Track name<sup>1)4)</sup>

#### When playing a VIDEO CD with PBC function:

- ① Elapsed playing time of the current scene
- ② Disc title<sup>1)4)</sup>

#### When playing MP3 audio tracks or DivX video files on a DATA CD/DVD:

- ① Elapsed playing time of the current track/file
- ② Track/file name<sup>5)6)</sup>

### Checking the total playing time and titles

Press TIME/TEXT **[34]** repeatedly when playback is stopped.  
Each time you press TIME/TEXT **[34]**, the display changes from ① → ② → ① → ...

#### DVD VIDEO or DVD-R/-RW in VR mode:

- ① Total number of titles on the disc
- ② Disc title<sup>1)</sup>

#### AUDIO CD or VIDEO CD without PBC playback:

- ① Total number of the tracks on the disc and the total playing time of the disc
- ② Disc title<sup>1)</sup>

#### VIDEO CD with PBC playback:

- ① Total number of scenes on the disc
- ② Disc title<sup>1)4)</sup>

<sup>1)</sup> "NO TEXT" appears in the display if the DVD VIDEO is not a DVD-TEXT disc, the AUDIO CD is not a CD-TEXT disc or the VIDEO CD does not have text information.

<sup>2)</sup> The current chapter number and the current title number are displayed for 2 seconds before the display returns to the elapsed playing time.

<sup>3)</sup> When Program Play or Shuffle Play is turned on, the elapsed playing time and the remaining time of the disc would be skipped.

- 4) The current track number and the current index number (for a disc without PBC) or the current scene number (for a disc with PBC) are displayed for 2 seconds before the display returns to the elapsed playing time.
- 5) When playing DivX video files, the current folder number and the current file number are displayed for 2 seconds before the display returns to elapsed playing time when you press TIME/TEXT **[34]** during display of title of the file.
- 6) If an MP3 audio track has the ID3 tag, the system will display an album name or title name from the ID3 tag information. The system supports ID3 ver 1.0/1.1/2.2/2.3. ID3 ver 2.2/2.3 tag information display has priority when both ID3 ver 1.0/1.1 and ver 2.2/2.3 tags are used for a single MP3 audio track.

## Notes

- If you play back a disc containing JPEG image files only, "JPEG" or "NO AUDIO" appears in the display.
- You cannot use TIME/TEXT **[34]** to change the display of disc information when:
  - a JPEG image file is played back.
  - playback is stopped for DATA CD/DVD with MP3 audio tracks and/or JPEG image files.
  - playback is stopped for DATA CD/DVD with DivX video files.
- If the MP3 audio track title contains characters which cannot be displayed, these characters will be displayed as " \_".
- The elapsed playing time of MP3 audio tracks and DivX video files may not be displayed correctly.

## Viewing information about the disc in the on-screen display

Press TIME/TEXT **[34]**.

Each time you press TIME/TEXT **[34]** while playing the disc, the display changes from ① → ② → ... → ① → ...

The time display that you can view on the TV screen depends on the disc you are playing.

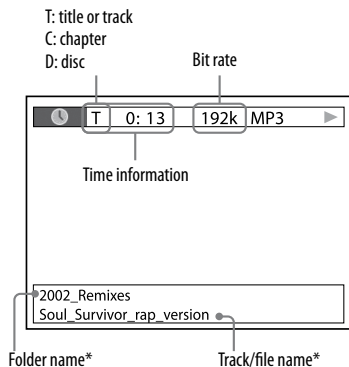

- \* If an MP3 audio track has the ID3 tag, the system will display an album name or title name from the ID3 tag information. The system supports ID3 ver 1.0/1.1/2.2/2.3. ID3 ver 2.2/2.3 tag information display has priority when both ID3 ver 1.0/1.1 and ver 2.2/2.3 tags are used for a single MP3 audio track.

**Note**

The Control Menu display will show different items depending on the disc type.

**When playing a DVD VIDEO or DVD-R/-RW in VR mode:**

- ① Elapsed playing time of the current title
- ② Remaining time of the current title
- ③ Elapsed playing time of the current chapter
- ④ Remaining time of the current chapter
- ⑤ Elapsed playing time of the current title and disc title

**When playing a VIDEO CD with PBC function:**

- ① Elapsed playing time of the current scene
- ② Disc title

**When playing an AUDIO CD or VIDEO CD without PBC function:**

- ① Elapsed playing time of the current track
- ② Remaining time of the current track
- ③ Elapsed playing time of the disc
- ④ Remaining time of the disc
- ⑤ Elapsed playing time of the current track and track name

**When playing MP3 audio tracks or DivX video files on a DATA CD/DVD:**

Elapsed playing time of the current track/file and folder/track/file name\*

- \* If an MP3 audio track has the ID3 tag, the system will display an album name or title name from the ID3 tag information. The system supports ID3 ver 1.0/1.1/2.2/2.3. ID3 ver 2.2/2.3 tag information display has priority when both ID3 ver 1.0/1.1 and ver 2.2/2.3 tags are used for a single MP3 audio track.

**Notes**

- Only alphabet letters, numbers and some symbols can be displayed.
- Depending on the disc, the system can only display a limited number of characters.
- For MP3 audio tracks with format other than ISO 9660 Level 1 and Level 2, folder name and track name may not be displayed.

## Displaying the audio information of the disc

(DVD VIDEO and DivX video files only)

When you press AUDIO [21] repeatedly during playback, the format of the current audio signal is displayed on the TV screen.

### When playing a DVD VIDEO:

For example, in Dolby Digital format, multiple signals ranging from monaural to 5.1 channel signals can be recorded on a DVD VIDEO.

Example:

For Dolby Digital 5.1 channel:

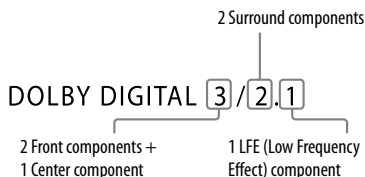

### When playing a DivX video file:

Example:

MP3 audio track

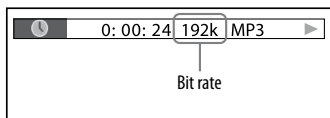

## Checking the date information of JPEG image files

You can check the date information during playback when "Exif"\* tag is recorded in the JPEG image files.

Press [DISPLAY] [25] repeatedly during playback.

The Control Menu appears.

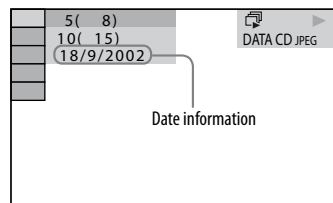

\* "Exchangeable Image File Format" is a digital camera image format defined by the "Japan Electronics & Information Technology Industries Association" (JEITA).

### Note

The date information format varies depending on the area.



## Hooking up optional components

To enhance your system, you can connect optional components. Refer to the operating instructions provided with each component.

### Rear panel

#### MHC-GZR9D

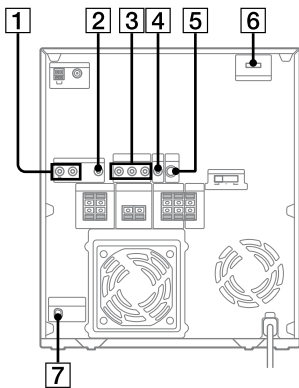

#### MHC-GZR8D

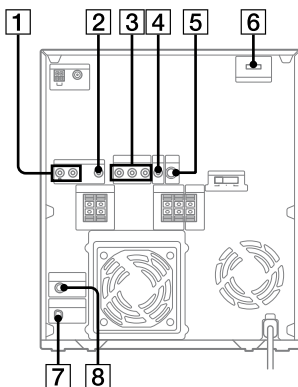

#### MHC-GZR7D

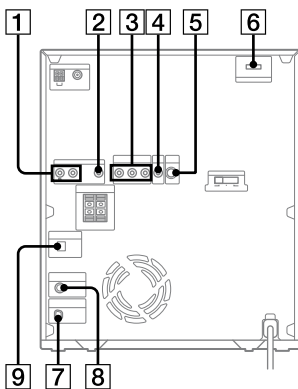

### 1 VIDEO/SAT AUDIO IN L/R jacks

Connect the audio output jacks of an optional component (such as VCR or satellite tuner).

### 2 VIDEO/SAT VIDEO IN jack

Connect the video output jack of an optional component (such as VCR or satellite tuner).

### 3 COMPONENT VIDEO OUT jacks

Connect the component video input jacks of the TV or projector. If your TV accept progressive format signals, you must use this connection and set "PROGRESSIVE (COMPONENT OUT)" to "ON" (page 28). You can enjoy higher quality video images.

#### Note

You cannot output the video signal from the VIDEO/SAT VIDEO IN jack through the COMPONENT VIDEO OUT jacks of this unit.

### 4 VIDEO OUT jack

Connect the video input jack of the TV or projector.

### 5 S VIDEO OUT jack

Connect the S Video input jack of the TV or projector. You can enjoy higher quality video images when you select the S VIDEO.

#### Note

You cannot output the video signal from the VIDEO/SAT VIDEO IN jack through the S VIDEO OUT jack of this unit.

### 6 DMPORT (DIGITAL MEDIA PORT)

Connect the DIGITAL MEDIA PORT adapter (not supplied). You need to connect the DIGITAL MEDIA PORT adapter to an optional audio device (portable audio player, etc.).

#### Notes

- Available DIGITAL MEDIA PORT adapters vary in each area.
- Do not connect an adapter other than the DIGITAL MEDIA PORT adapter.
- Do not connect or disconnect the DIGITAL MEDIA PORT adapter to/from the DMPORT while the system is on.
- When using a DIGITAL MEDIA PORT adapter (not supplied) that has video output function, connect the adapter directly to the TV.

### 7 D-LIGHT SYNC OUT jack (Except for Russian and Australian models)

Connect the D-LIGHT SYNC controller (not supplied). You need to connect the D-LIGHT SYNC controller to the lighting device\* (not supplied). The lighting device will react according to control signals transmitted by the D-LIGHT SYNC controller upon receiving music source from the system. For details on the use of D-LIGHT SYNC controller and lighting device, refer to the respective operating instructions supplied with the respective device.

\* Refer to the D-LIGHT SYNC controller operating instruction for the recommended lighting device.

#### Note

The lighting effect may be different depending on the connected lighting device or the type of music being played back.

### 8 SUBWOOFER OUT jack (MHC- GZR8D/GZR7D only)

Connect the audio input jack of an optional subwoofer\*.

\* SA-GNV111D is recommended. In some areas, the SA-GNV111D may not yet be available.

#### Note

The effect may be limited or noise may occur depending on the connected subwoofer or the type of music being played back.

### 9 DVD DIGITAL OUT jack (MHC- GZR7D only)

Connect the digital optical input jack of an optional digital component (such as amplifier). You can enjoy 5.1 channel sound, if the connected amplifier equipped with Dolby Digital or DTS decoder.

#### Notes

- Sound is output only when the system function is set to "DVD" or "USB."
- If you press AUDIO [2], SOUND FIELD [7] or the buttons related to Karaoke Mode, or if you connect or disconnect microphones or headphones, the sound cuts off for a moment.

## Listening to a connected VCR or satellite tuner

- 1 Press FUNCTION +/- [16] repeatedly (or press VIDEO/SAT [16] on the unit) to select "VIDEO" or "SAT."
- 2 Start playing the connected component.

### To switch between the "VIDEO" and "SAT" function

Hold down VIDEO/SAT [16] on the unit and press OPTIONS [9] on the unit while the system is on. The system switches the function from "VIDEO" to "SAT" or vice versa.

#### Note

If the sound is distorted or too loud when "VIDEO" is selected, change the function to "SAT."

## Using the DIGITAL MEDIA PORT adapter

- 1 Press FUNCTION +/- [16] repeatedly (or press DMPORT [16] on the unit) to select "DMPORT."
- 2 Start playing the connected component.

The sound from the connected component is played on the system. For operation details, see the operating instructions of the DIGITAL MEDIA PORT adapter (not supplied).

#### Note

Depending on the type of DIGITAL MEDIA PORT adapter (not supplied), you may be able to operate the connected component using either the buttons on the remote or the unit.

## Enjoying the multi channel sound with the optional amplifier (MHC-GZR7D only)

- 1** Connect the digital optical cord.  
See “Hooking up optional components” (page 113).
- 2** Connect the speakers (not supplied) to an optional amplifier equipped with a decoder.  
For the speakers placement, refer to the operating instructions supplied with the connected amplifier.
- 3** Start playing a multi channel source, such as a DVD VIDEO.
- 4** Select the audio format you want.  
See “Changing the sound” (page 41).

## Additional Information

### Troubleshooting

Should you encounter a problem with your system, do the following:

- 1 Make sure the power cord and speaker cords are connected correctly and firmly.
- 2 Find your problem in the troubleshooting checklist below and take the indicated corrective action.

If the problem persists after doing all of the above, consult your nearest Sony dealer.

#### **If the STANDBY indicator flashes**

Immediately unplug the power cord, and check the following items.

- If your system has a voltage selector, is the voltage selector set to the correct voltage?
- Are you using only the supplied speakers?
- Are the + and – speaker cords short-circuited?
- Is anything blocking the ventilation holes on the rear of the system?

After the STANDBY indicator **1** stops flashing, reconnect the power cord, and turn on the system. If the issue persists, contact your nearest Sony dealer.

### General

**The display starts flashing as soon as you plug in the power cord even though you have not turned on the system.**

- Press DISPLAY **2** once while the system is off. The demonstration disappears.

**“- :-” appears in the display.**

- A power failure has occurred. Set the clock (page 33) and timer settings (page 105) again.

**The system does not turn on.**



- Is the power cord plugged in?
- Is the voltage selector set correctly to match the local power line voltage? (For models with a voltage selector only)

**The clock or timer setting is canceled.**



- The power cord is disconnected or a power failure occurred. Redo “Setting the clock” (page 33). If you have set the timer, redo “Using the timer” (page 105).

**There is no sound.**

- Press VOLUME + repeatedly (or turn MASTER VOLUME on the unit clockwise) **15**.
- The headphones are connected to the PHONES jack **14**.

- Check the speaker connections (page 23).
- There is no audio output during Rec Timer.
- The system is in pause mode, in Slow-motion Play or in Lock Search. Press  (or  on the unit)  to start the playback.
- No sound is output when transferring music to the USB device.

#### **There is no microphone sound.**

- Press VOLUME + repeatedly (or turn MASTER VOLUME on the unit clockwise)  or turn MIC LEVEL  on the unit clockwise to adjust the microphone volume.
- Make sure the microphone is connected to the MIC jack  correctly.
- Make sure the microphone is turned on.

#### **There is severe hum or noise.**

- A TV or VCR is placed too close to the unit. Move the unit away from the TV or VCR.
- Move the unit away from the source of noise.
- Connect the unit to a different wall outlet.
- Install a noise filter (commercially available) to the power cord.

#### **The timer does not function.**

- Check the timer setting and set the correct time (page 105).
- Cancel the Sleep Timer function.

#### **The remote does not function.**

- Remove the obstacles between the remote and the unit.
- Move the remote closer to the unit.
- Point the remote at the unit's sensor.
- Replace the batteries (R6/size AA).
- Locate the unit away from the fluorescent light.

#### **There is acoustic feedback.**

- Reduce the volume.
- Move the microphone away from the speakers or change the direction of the microphone.

#### **The color irregularity on a TV screen persists.**

- Turn off the TV set once, then turn it on after 15 to 30 minutes. If the color irregularity still persists, place the speakers farther away from the TV set.

#### **The sound from the component connected to the VIDEO/SAT AUDIO IN L/R jacks is distorted.**

- If "VIDEO" appears in the display when you press VIDEO/SAT  on the unit, switch the display to "SAT" (see "To switch between the "VIDEO" and "SAT" function" (page 116)).

#### **"THEATRE SYNC" function does not work.**

- If distance between the TV and this unit is too far, this function may not work. Install the unit near the TV.

## Speakers

---

### Sound comes from one channel or unbalanced left and right volume.

- Place the speakers as symmetrically as possible.
- Check that the speakers are connected securely and correctly.
- The source being played back is monaural.

### Sound lacks bass.

- Check that the speaker's + and - terminals are connected correctly.

### The sound comes from the center speaker only (MHC-GZR9D/GZR8D only).

- Depending on the disc, the sound may come from the center speaker only.

### There is no sound from the subwoofer.

- Make sure that "SUBWOOFER" setting is set to "YES."
- Set the subwoofer level to the appropriate level.
- No sound is produced from the subwoofer when you play back a DVD VIDEO that does not have subwoofer output recorded.
- Check that the subwoofer is connected securely and correctly.
- For MHC-GZR9D, check that the SUBWOOFER indicator **[18]** on the unit is lit.

### There is no sound from the center/surround speaker (MHC-GZR9D/GZR8D only).

- Set the center/surround speaker level to the appropriate level.
- The software being played back has limited sound effects. Check the volume with the test tone (page 70).
- Check that the center/surround speakers are connected securely and correctly.
- Make sure that "SURROUND" is set to "SIDE" or "BEHIND."
- Make sure that "CENTER" is set to "YES."

## Disc Player

---

### The disc does not eject and "LOCKED" appears in the display.

- Consult your nearest Sony dealer or local authorized Sony service facility.

### The disc tray **[4]** does not close.

- Load the disc correctly.
- Always close the disc tray **[4]** by pressing **▲ OPEN/CLOSE [10]** on the unit. Do not forcibly push the disc tray to close it as this may cause a malfunction.



**The disc does not eject.**

- You cannot eject the disc when performing CD Synchro Recording or when transferring music from a disc. Press **■** [12] to cancel the operation, then press **▲** OPEN/CLOSE [10] on the unit to eject the disc.
- Consult your nearest Sony dealer.

**Playback does not start.**

- Check whether a disc is loaded.
- Wipe the disc clean (page 133).
- Reload the disc.
- Load the disc that this system can play back (page 7).
- Load the disc on the disc tray [4] with the label side facing up.
- Remove the disc and wipe away the moisture on the disc, then leave the system turned on for a few hours until the moisture evaporates.
- Press **▷** (or **◀▶** on the unit) [12] to start playback.
- The region code on the DVD VIDEO does not match the system.

**The sound skips.**

- Wipe the disc clean (page 133).
- Reload the disc.
- Move the unit to a place without vibration (e.g., on top of a stable stand).
- Move the speakers away from the unit, or place them on separate stands. When you listen to a track with bass sounds at high volume, the speaker vibration may cause the sound to skip.

**Playback does not start from the first track.**

- Shuffle Play mode, Program Play mode or Repeat Play mode is selected.
- Resume Play has been selected. Press **■** [12] twice. Then, press **▷** (or **◀▶** on the unit) [12] to start playback (page 43).
- The title of DVD VIDEO or PBC menu automatically appears on the TV screen.

**Playback starts automatically.**

- The DVD VIDEO features an auto playback function.

**Playback stops automatically.**

- Some discs may contain an auto pause signal. While playing such a disc, the playback stops at auto pause signal.

**You cannot perform some functions such as Stop, Lock Search, Slow-motion Play, Repeat Play, Shuffle Play or Program Play.**

- Depending on the disc, you may not be able to do some of the operations above. Refer to the operating instructions supplied with the disc.

**The DATA CD/DVD (MP3 audio track/JPEG image file/DivX video file) cannot be played back.**

- The DATA CD is not recorded in a format that conforms to ISO 9660 Level 1, Level 2, or Joliet (expansion format).

- The DATA DVD is not recorded in a format that conforms to UDF (Universal Disk Format).
- The MP3 audio track does not have the extension “.mp3”.
- The data is not stored in the desired format.
- The MP3 audio tracks in format other than MPEG 1 Audio Layer 3 cannot be played back.
- The system can play back to a depth of 8 folders only.
- For MP3 audio tracks/JPEG image files, check the “MODE (MUSIC, IMAGE)” setting (page 55).
- The disc contains more than 200 folders.
- The folder contains more than 150 tracks/files.
- The JPEG image file does not have the extension “.jpg” or “.jpeg”.
- The JPEG image file is larger than 3,072 (width) × 2,048 (height) in normal mode, or more than 2,000,000 pixels in Progressive JPEG mode which is mainly used on the Internet website.
- JPEG image files with a high width to length ratio cannot be played back.
- For MP3 audio tracks and JPEG image files, the DATA CD/DVD contains a DivX video file.
- The DivX video file does not have the extension “.avi” or “.divx”.
- The DivX video file is larger than 720 (width) × 576 (height).

### **The MP3 audio tracks take longer time to play back than others.**

- After the system reads all the tracks on the disc, playback may take more time than usual if:
  - the number of folders or tracks on the disc is very large.
  - the folder and track organization structure is very complex.

### **“Data error” appears on the TV screen when playing a DATA CD/DVD.**

- The MP3 audio track/JPEG image file you want to play is broken.
- The data is not MPEG 1 Audio Layer 3 data.
- The JPEG image file format does not conform to DCF.
- The JPEG image file has the extension “.jpg” or “.jpeg”, but is not in JPEG format.
- The DivX video file has the extension “.avi” or “.divx”, but is not in DivX format.
- The DivX video file does not conform to a DivX Certified profile.



### **The disc title, CD-TEXT and DVD-TEXT characters do not appear properly.**

- Use a disc that conforms to the ISO 9660 Level 1, Level 2, or Joliet (expansion).
- The character code that can be displayed by this system are as follows:
  - Upper cases (A to Z)
  - Numbers (0 to 9)
  - Symbols (< > \* +, ? / [ ] \ \_)
 Other characters appear as “\_”.

**The surround effect is difficult to hear when you are playing a Dolby Digital or MPEG audio sound track.**

- Make sure the sound field is set properly (page 95).
- Check the speaker connection (page 23).
- Depending on the DVD VIDEO, the output signal may not be the entire 5.1 channel. It may be monaural or stereo, even if the sound track is recorded in Dolby Digital or MPEG audio format.

**The sound loses stereo effect when you play back a DVD VIDEO, VIDEO CD, AUDIO CD, MP3 audio track or DivX video file.**

- Unplug the microphone or press KARAOKE MODE  repeatedly until “” disappears from the display.
- Make sure the system is connected properly.
- Check the speaker connection (page 23).

## USB device

---

**You cannot start transferring or recording to an USB device.**

- The following problems may have occurred.
  - The USB device is full.
  - The number of tracks and folders on the USB device has reached the upper limit.
  - The USB device is write-protected.

**Transferring or recording is stopped before it is finished.**

- You are using an unsupported USB device. Refer to “Compatible USB devices” (supplement) for the supported device types.
- The USB device is not formatted correctly. Refer to the operating instructions supplied with the USB device for how to format.
- Turn off the system and remove the USB device. If the USB device has a power switch, turn the USB device off and then on again after removing it from the system. Then perform transferring again.
- If the transfer, recording and erase operations are repeated multiple times, the file structure within the USB device becomes fragmented. Refer to the operating instructions supplied with the USB device for how to deal with this problem. If the problem persists, contact your nearest Sony dealer.

**Transferring or recording results in an error.**

- You are using an unsupported USB device. Refer to “Compatible USB devices” (supplement) for the supported device types.
- Turn off the system and remove the USB device. If the USB device has a power switch, turn the USB device off and then on again after removing it from the system. Then perform transferring again.

- The USB device was disconnected or the power was turned off during the transfer process. Delete the partially-transferred track or partially-recorded track, and perform transferring or recording again. If this does not fix the problem, the USB device may be broken. Refer to the operating instructions supplied with the USB device for how to deal with this problem. If the problem persists, contact your nearest Sony dealer.



#### **Tracks or folders on the USB device cannot be erased.**

- Check if the USB device is writeprotected.
- The USB device was disconnected or the power was turned off during the erase operation. Delete the partially-erased track. If this does not fix the problem, the USB device may be broken. Refer to the operating instructions supplied with the USB device for how to deal with this problem. If the problem persists, contact your nearest Sony dealer.

#### **Are you using a supported USB device?**

- If you connect an unsupported USB device, the following problems may occur. Refer to “Compatible USB devices” (supplement) for the supported device types.
  - The USB device is not recognized.
  - Track, file or folder names are not displayed on this system.
  - Playback is not possible.
  - The sound skips.
  - There is noise.
  - A distorted sound is output.
  - Transferring or recording stops before it is finished.

#### **“OVER CURRENT” appears.**



- A problem has been detected with the level of electrical current from the  (USB) port [17](#). Turn off the system and remove the USB device from the  (USB) port [17](#). Make sure there is no problem with the USB device. If this display pattern persists, contact your nearest Sony dealer.

#### **There is no sound.**

- The USB device is not connected correctly. Turn off the system and reconnect the USB device, then turn on the system and check if “USB MEMORY” lights up.

#### **There is noise, skipping, or distorted sound.**

- Turn off the system, then reconnect the USB device.
- The music data itself contains noise, or the sound is distorted. Noise may have entered during the transfer process or recording. Delete the track, and try transferring or recording again.
- The bit rate used when encoding audio files was low. Send audio files with higher bit rate to the USB device.

**The USB device cannot be connected into the  (USB) port .**

- The USB device is being connected backwards. Connect the USB device in the correct orientation.

**“READING” is displayed for an extended time, or it takes a long time before playback starts.**

- The reading process can take a long time in the following cases.
  - There are many folders, tracks or files on the USB device.
  - The file structure is extremely complex.
  - The memory capacity is excessive.
  - The file size is extremely large.
  - The internal memory is fragmented.
 Thus, we recommend following these guidelines.
  - Total folders on USB device: 200 or less
  - Total tracks or files per folder: 150 or less

**Erroneous display**

- Send the music data to the USB device again, as the data stored in the USB device may have been corrupted.
- The character code that can be displayed by this system are as follows:
  - Upper cases (A to Z)
  - Numbers (0 to 9)
  - Symbols (< > \* +, ? / [ ] \ \_)
 Other characters appear as “\_”.



**The USB device is not recognized.**

- Turn off the system and reconnect the USB device, then turn on the system.
- Connect the supported USB device (Refer to “Compatible USB devices” (supplement)).
- The USB device does not work properly. Refer to the operating instructions supplied with the USB device for how to deal with this problem. If the problem persists, contact your nearest Sony dealer.

**“Data error” appears on the display when playing an USB device.**

- The audio track/JPEG image file you want to play is broken.
- The JPEG image file format does not conform to DCF.
- The JPEG image file has the extension “.jpg” or “.jpeg”, but is not in JPEG format.

**Play does not start.**

- Turn off the system and reconnect the USB device, then turn on the system.
- Connect the supported USB device (Refer to “Compatible USB devices” (supplement)).
- Press  (or  on the unit)  to start play.

**Play does not start from the first track.**

- Set the play mode to Normal Play mode.

### **Tracks or files cannot be played back.**

- The MP3 audio track does not have the extension “.mp3”.
  - The WMA audio track does not have the extension “.wma”.
  - The AAC audio track does not have the extension “.m4a”.
  - The audio track is not stored in MP3/WMA/AAC format.
  - The JPEG image file does not have the extension “.jpg” or “.jpeg”.
  - The JPEG image file is larger than 3,072 (width) × 2,048 (height) in normal mode, or more than 2,000,000 pixels in Progressive JPEG mode which is mainly used on the Internet website.
  - JPEG image files with a high width to length ratio cannot be played back.
  - Check the “MODE (MUSIC, IMAGE)” setting (page 87, 88).
  - USB device formatted with file systems other than FAT12, FAT16 or FAT32 are unsupported.\*
  - The MP3 audio tracks in format other than MPEG 1 Audio Layer 3 cannot be played back.
  - A WMA audio track that is the WMA DRM, WMA Lossless, or WMA PRO format cannot be played back.
  - An AAC audio track that is the AAC DRM or AAC Lossless format cannot be played back.
  - AAC audio tracks encoded at 96 kHz cannot be played back.
  - If you use a partitioned USB device, only tracks or files on the first partition can be played.
  - The system can play back to a depth of 8 folders only.
  - The number of folders has exceeded 200.
- The number of tracks or files has exceeded 150.
  - Tracks or files that are encrypted or protected by passwords, etc. cannot be played back.
- \* This system supports FAT12, FAT16 and FAT32, but some USB devices may not support all of these FAT. For details, see the operating instructions of each USB device or contact the manufacturer.

---

### **Picture**

#### **There is no picture.**

- The “VIDEO/SAT” function is selected, but there is no input signal.
- Check that the system is connected securely.
- The video cord is damaged. Replace it with a new one.
- Make sure you connect the unit to the video input jack of your TV (page 26).
- Make sure you turn on the TV and operate the TV correctly.
- Make sure you select the video input on the TV so that you can view the pictures from the system.
- Make sure you set the color system correctly, according to your TV’s color system (Except for Russian and Latin American models).
- Make sure you connect the unit and your TV using only the supplied video cord.

- Set “PROGRESSIVE (COMPONENT OUT)” to “OFF” if you connect your TV to the COMPONENT VIDEO OUT jacks and your TV cannot accept progressive signal.
- You have set to progressive format but your TV cannot accept the signal in progressive format. In this case, connect the VIDEO OUT jack or the S-VIDEO OUT jack to the TV and set to the Interlace format (page 28).
- Even if your TV is compatible with progressive format (525p/625p) signals, the image may be affected when you set to progressive format. In this case, set to interlace format (the default setting) (page 28).

#### **Picture noise appears.**

- Wipe the disc clean (page 133).
- If video signal from your system has to go through your VCR to your TV, the copy-protection applied to some DVD VIDEO programs could affect the picture quality. If you still experience problems after checking your connections, connect your system directly to your TV's S Video input (page 27, 114).
- Keep the speaker cords away from the antennas.
- When you play back a VIDEO CD recorded in a different color system from the one you set to the system, the picture image may be distorted (Except for Russian and Latin American models) (page 27, 66).

- When you connect your TV to the COMPONENT VIDEO OUT jacks and play back video-based software in progressive signal format, some sections of the image may appear unnatural due to the conversion process.
- Set the color system to match your TV (Except for Russian and Latin American models) (page 27, 66).

#### **The aspect ratio of the TV screen cannot be changed even though you can set “TV TYPE” under “VIDEO SETUP” in the Setup Menu when you play back a wide picture.**

- The aspect ratio is fixed on your DVD VIDEO.
- If you connect the unit with the S Video cord, connect directly to the TV. Otherwise, you may not change the aspect ratio.
- Depending on the TV, you may not change the aspect ratio.

#### **Messages do not appear on the TV screen in the language you want.**

- Select the language you want for the on-screen display in “OSD” under “LANGUAGE SETUP” in the Setup Menu (page 64).

#### **The language for the sound track cannot be changed.**

- Multilingual tracks are not recorded on the DVD VIDEO being played back.
- The DVD VIDEO prohibits changing the language for the sound track.

### **The subtitles language cannot be changed.**

- Multilingual subtitles are not recorded on the DVD VIDEO being played back.
- The DVD VIDEO prohibits changing the subtitles.

### **The subtitles cannot be turned off.**

- The DVD VIDEO prohibits turning off subtitles.

### **The angles cannot be changed.**

- Multi-angles are not recorded on the DVD VIDEO being played back.
- The DVD VIDEO prohibits changing the angles.

## **Tuner**

---

### **The radio presetting is canceled.**

- The power cord is disconnected or a power failure occurred for longer than a day. Redo "Listening to a preset radio station" (page 71).

### **There is severe hum or noise. ("TUNED" or "STEREO" flashes in the display)**

- Set the proper band and frequency (page 71).
- Connect the antenna properly (page 23).
- Find a place and an orientation that provide good reception, then set up the antenna again. If you cannot obtain good reception, we recommend that you connect a commercially available external antenna.

- The supplied FM lead antenna receives signals along its entire length, so make sure you extend it fully.
- Locate the antennas as far away from the speaker cords and the power cord as possible, to avoid picking up noise.
- Try turning off the surrounding electrical equipment.

### **A stereo FM program cannot be received in stereo.**

- Press REPEAT/FM MODE **20** repeatedly until "MONO" disappears from the display.

## **Tape deck**

---

### **The tape does not record or playback, or there is a decrease in sound level.**

- The tape heads are dirty (see "Cleaning the tape heads" (page 134)).
- The record/playback heads are magnetized (see "Demagnetizing the tape heads" (page 134)).

### **The tape does not erase completely.**

- The record/playback heads are magnetized (see "Demagnetizing the tape heads" (page 134)).

### **There is excessive wow or flutter, or the sound drops out.**

- The capstans or pinch rollers are dirty (see "Cleaning the tape heads" (page 134)).



### Noise increases or the high frequencies are erased.

- The record/playback heads are magnetized (see “Demagnetizing the tape heads” (page 134)).

### The tape does not record.

- No tape is loaded. Load a tape.
- The tab has been removed from the tape. Cover the broken tab with adhesive tape (page 134).
- The tape has reeled to the end.

## Optional components

---

### There is no sound.

- Refer to General item “There is no sound.” (page 118) and check the condition of the system.
- Connect the component properly (page 113) while checking:
  - if the cords are connected properly.
  - if the cord plugs are firmly inserted all the way.
- Turn on the connected component.
- Refer to the operating instructions supplied with the connected component and start playing.

### If the system still does not operate properly after performing the above measures or other troubles not described above occur, reset the system as follows:

Use buttons on the unit to reset the system to its factory default settings.

- 1 Unplug the power cord.
- 2 Plug the power cord back in.
- 3 Press I/⏻ [1] to turn on the system.
- 4 While holding down ENTER [6], press ILLUMINATION [2] and press I/⏻ [1] at the same time.  
“COLD RESET” appears in the display. The system is reset to the factory settings except for the “SETUP” settings. You should set the settings you made, such as the preset stations, clock and timer.

## To return the "SETUP" settings to the default settings\*, perform reset as follows:

- 1 Press DISPLAY [25] when playback is stopped.  
The Control Menu appears on the TV screen.
- 2 Press or [29] repeatedly to select (SETUP), then press ENTER [6].
- 3 Press or [29] repeatedly to select "CUSTOM," then press ENTER [6].  
The Setup Menu appears.
- 4 Press or [29] repeatedly to select "SYSTEM SETUP," then press ENTER [6].
- 5 Press or [29] repeatedly to select "RESET," then press ENTER [6].
- 6 Press or [29] repeatedly to select "YES," then press ENTER [6].  
It takes a few seconds to complete. Do not press I/⏻ [1] when resetting the system.

\* Except for "PARENTAL CONTROL" settings

## Self-diagnosis Function

(When letters/numbers appear in the display)

When the self-diagnosis function is activated to prevent the system from malfunctioning, a 5-character service number (e.g. C 13 50) with a combination of a letter and 4 digits appears on the TV screen or the front panel display. In this case, check the following table.

First 3 characters of the service number	Cause and corrective action
C 13	This disc is dirty. <ul style="list-style-type: none"><li>• Clean the disc with a soft cloth (page 133).</li></ul>
C 31	The disc is not inserted correctly. <ul style="list-style-type: none"><li>• Restart the system, then re-insert the disc correctly.</li></ul>
E XX (XX is a number)	To prevent a malfunction, the system has performed the self-diagnosis function. <ul style="list-style-type: none"><li>• Contact your nearest Sony dealer or local authorized Sony service facility and give the 5-character service number. Example: E 61 10</li></ul>

## When displaying the version number on the TV screen

When you turn on the system, the version number [VER.X.XX] (X is a number) may appear on the TV screen. Although this is not a malfunction and for Sony service use only, normal system operation will not be possible. Turn off the system, and then turn on the system again to operate.

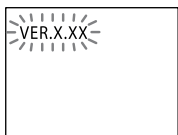

## Messages

One of the following messages may appear or flash in the front panel display during operation.

### **CANNOT PLAY**

- A disc that cannot be played back was inserted.
- A DVD VIDEO with unsupported region code was inserted.

### **DATA ERROR (for USB devices)**

You tried to play a track that is not playable.

### **DATA ERROR (for DATA CD/DVDs)**

- The MP3 audio track, JPEG image file and DivX video file you want to play back is damaged.
- The MP3 audio track does not conform to MPEG 1 Audio Layer 3 format.
- The JPEG image file does not conform to DCF format.
- The MP3 audio track has the extension “.mp3” but it is not in MP3 format.
- The JPEG image file has the extension “.jpg” or “.jpeg” but it is not in JPEG format.
- The DivX video file does not conform to a DivX Certified profiles.
- The DivX video file has the extension “.avi” or “.divx” but it is not in DivX format.

### **DEVICE ERROR**

The USB device could not be recognized or an unknown device is connected.

### **DEVICE FULL**

The USB device is full.

### **DVD NO DISC**

There is no disc on the disc tray [4].

**ERASE ERROR**

Erase of audio tracks or folders on the USB device failed.

**FATAL ERROR**

The USB device has been disconnected while transferring to the USB device.

**FOLDER FULL**

The number of folders on the USB device has reached the maximum.

**INVALID**

You have pressed an invalid button.

**JPEG**

The playback mode is "IMAGE" and a JPEG image file is being played back.

**NO AUDIO**

The connected USB device or the loaded DATA CD/DVD does not contain audio tracks.

**NO DEVICE**

No USB device is connected.

**NO IMAGE**

The connected USB device or the loaded DATA CD/DVD does not contain image files.

**NO TAB**

You cannot record the tape because the tab has been removed from the tape.

**NO TAPE**

There is no tape in the tape deck.

**NOT IN USE**

You have pressed a button whose operation is not allowed or invalid at that time.

**NOT SUPPORT**

- An unsupported USB device is connected.
- The USB device is connected to this system through a hub.

**OFF TIME NG**

The on time and off time of Play Timer or Rec Timer is the same.

**OVER CURRENT**

An over current from the  (USB) port **17** was detected.

**PLEASE WAIT**

- The system is doing initialization process.
- The system is readying for usage of an USB device.

**PROTECTED**

The USB device is write-protected.

**PUSH STOP**

You have pressed the buttons whose operation is only possible when playback is stopped.

**READING**

- The system is reading information of the disc. Some buttons are not available.
- The system is recognizing the USB device.

**REC ERROR**

Transferring did not start, stopped partway, or otherwise could not be performed.

**TRACK FULL**

The number of audio tracks on the USB device has reached the maximum.

---

## Precautions

### Notes on discs

- Before playing, wipe the disc with a cleaning cloth from the center out to the edge.
- Do not clean discs with solvents, such as benzine, thinner, or commercially available cleaners or anti-static spray intended for vinyl LPs.
- Do not expose discs to direct sunlight or heat sources such as hot air ducts, nor leave it in a car parked in direct sunlight.

### On cleaning discs, disc/lens cleaner

Do not use a commercially available cleaning disc or disc/lens cleaner (wet or spray type). These may cause apparatus to malfunction.

### On operating voltage

Before operating the system, check that the operating voltage of the unit is identical with the voltage of your local power supply.

### On safety

- Completely disconnect the power cord (mains lead) from the wall socket (mains) if it is not going to be used for an extended period of time. When unplugging the unit, always grip the plug. Never pull the cord itself.
- Should any solid object or liquid get into the system, unplug the system, and have it checked by qualified personnel before operating it again.

### On placement

- Do not place the system in an inclined position or in locations that are extremely hot, cold, dusty, dirty, or humid or lacking adequate ventilation, or subject to vibration, direct sunlight or a bright light.
- Be careful when placing the unit or speakers on surfaces that have been specially treated (for example, with wax, oil, polish) as staining or discoloration of the surface may result.
- If the system is brought directly from a cold to a warm location or is placed in a very damp room, moisture may condense on the lens inside the DVD player, and cause the system to malfunction. In this situation, remove the disc, and leave the system turned on for about an hour until the moisture evaporates.

### On heat buildup

- Heat buildup on the unit during operation is normal and is not cause for alarm.
- Do not touch the cabinet if it has been used continuously at a high volume because the cabinet may have become hot.
- Do not obstruct the ventilation holes.

### **In case color irregularity is observed on a nearby TV screen**

With the magnetically shielded type of speakers, the speakers can be installed near a TV set. However, color irregularity may still be observed on the TV screen depending on the type of your TV set. In this situation, turn off the TV, wait 15 to 30 minutes, and turn it back on. If there is no improvement, move the speakers far away from the TV.

#### **IMPORTANT NOTICE**

**Caution:** If you leave a still video image or on-screen display image displayed on your TV for an extended period of time via this system, you risk permanent damage to your TV screen. Projection TVs are especially susceptible to this.

### **Cleaning the cabinet**

Clean this system with a soft cloth slightly moistened with a mild detergent solution. Do not use any type of abrasive pad, scouring powder, or solvent, such as thinner, benzine, or alcohol.

### **To prevent a tape from being accidentally recorded over**

Break off the cassette's overwrite protection tab from side A or B as illustrated.

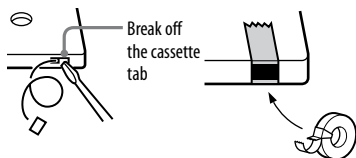

To later reuse the tape for recording, cover the broken tab with adhesive tape.

### **About a tape longer than 90 minutes**

The use of the tape with more than 90 minutes of play time is not recommended except for long, continuous recording or playback.

### **Cleaning the tape heads**

Use dry- or wet-type cleaning cassette (available separately) after every 10 hours of use, before you start an important recording, or after playing an old tape. Failure to clean the tape heads can cause degraded sound quality or an inability of the unit to record or play tapes. For details, refer to the instructions of the cleaning cassette.

### **Demagnetizing the tape heads**

Use a demagnetizing cassette (available separately) after every 20 to 30 hours of use. Failure to demagnetize the tape heads can cause an increase in noise, a loss of high frequency sound, and an inability to completely erase tapes. For details, refer to the instructions of the demagnetizing cassette.

# Specifications

## Main unit

### Amplifier section

The following measured at AC 230 V, 50/60 Hz (Russian model)

The following measured at AC 127, 220, 240 V, 50/60 Hz (Saudi Arabian model)

The following measured at AC 120, 220, 240 V, 50/60 Hz (Other models)

### MHC-GZR9D

Power output (rated):

100 W + 100 W (6  $\Omega$  at 1 kHz, 1% THD)

RMS output power (reference)

Front speaker:

180 W + 180 W (per channel at 6  $\Omega$ , 1 kHz, 10% THD)

Center speaker:

60 W (6  $\Omega$  at 1 kHz, 10% THD)

Surround speaker:

60 W + 60 W (per channel at 6  $\Omega$ , 1 kHz, 10% THD)

Subwoofer:

180 W (6  $\Omega$  at 80 Hz, 10% THD)

### MHC-GZR8D

Power output (rated):

100 W + 100 W (6  $\Omega$  at 1 kHz, 1% THD)

RMS output power (reference)

Front speaker:

180 W + 180 W (per channel at 6  $\Omega$ , 1 kHz, 10% THD)

Center speaker:

60 W (6  $\Omega$  at 1 kHz, 10% THD)

Surround speaker:

60 W + 60 W (per channel at 6  $\Omega$ , 1 kHz, 10% THD)

### MHC-GZR7D

Power output (rated):

100 W + 100 W (6  $\Omega$  at 1 kHz, 1% THD)

RMS output power (reference):

180 W + 180 W (per channel at 6  $\Omega$ , 1 kHz, 10% THD)

### Inputs

VIDEO/SAT VIDEO IN (phono jack):

1 Vp-p, 75 ohms

VIDEO/SAT AUDIO IN L/R (phono jacks):

voltage 250/450 mV, impedance 47 kilohms

MIC 1/MIC 2 (phone jacks):

sensitivity 1 mV, impedance 10 kilohms

### Outputs

VIDEO OUT (phono jack):

max. output level 1 Vp-p, unbalanced, Sync negative, load impedance 75 ohms

S VIDEO OUT (4-pin/mini-DIN jack):

Y: 1 Vp-p, unbalanced, Sync negative,

C: 0.286 Vp-p, load impedance

75 ohms

COMPONENT VIDEO OUT:

Y: 1 Vp-p, 75 ohms

PB/CB: 0.7 Vp-p, 75 ohms

PR/CR: 0.7 Vp-p, 75 ohms

DVD DIGITAL OUT (MHC-GZR7D only)

(Square optical connector jack, rear panel):

Wavelength 660 nm

PHONES (stereo mini jack):

accepts headphones of 8 ohms or more

SUBWOOFER OUT (MHC-GZR8D/

GZR7D only):

Voltage 1 V, impedance 1 kilohms

#### FRONT SPEAKER:

MHC-GZR9D:

Use only the supplied speaker SS-GZR9D.

MHC-GZR8D/GZR7D:

Use only the supplied speaker SS-GZR8D.

#### SURROUND SPEAKER (MHC-GZR9D/GZR8D only):

Use only the supplied speaker SS-RSX9D.

#### CENTER SPEAKER (MHC-GZR9D/GZR8D only):

Use only the supplied speaker SS-CTX9D.

#### SUBWOOFER (MHC-GZR9D only):

Use only the supplied subwoofer SS-WGV9D.

### USB section

#### Supported bit rate

MP3 (MPEG 1 Audio Layer-3):

32 – 320 kbps

WMA: 48 – 192 kbps

AAC: 48 – 320 kbps

#### Sampling frequencies

MP3 (MPEG 1 Audio Layer-3):

32/44.1/48 kHz

WMA: 44.1 kHz

AAC: 44.1 kHz

#### (USB) port:

Maximum current:

500 mA

### Disc player section

#### System:

Compact disc and digital audio and video system

#### Laser Diode Properties

Emission duration: Continuous

Laser Output\*: Less than 44.6 $\mu$ W

\* This output is the value measurement at a distance of 200mm from the objective lens surface on the Optical Pick-up Block with 7mm aperture.

#### Frequency response

DVD (PCM 48 kHz): 2 Hz – 22 kHz ( $\pm 1$  dB)

CD: 2 Hz – 20 kHz ( $\pm 0.5$  dB)

#### Video color system format

Russian model: PAL

Latin American model: NTSC

Other models: NTSC and PAL

### Tape deck section

#### Recording system:

4-track 2-channel, stereo

### Tuner section

FM stereo, FM/AM superheterodyne tuner

#### FM tuner section

##### Tuning range:

87.5 – 108.0 MHz (50 kHz step)

##### Antenna:

FM lead antenna

##### Antenna terminals:

75  $\Omega$  unbalanced

##### Intermediate frequency:

10.7 MHz



## AM tuner section

### Tuning range:

Russian and Saudi Arabian models:

531 — 1,602 kHz (9 kHz step)

Latin American model:

530 — 1,710 kHz (with 10 kHz tuning interval)

531 — 1,710 kHz (with 9 kHz tuning interval)

Australian model:

531 — 1,710 kHz (with 9 kHz tuning interval)

530 — 1,710 kHz (with 10 kHz tuning interval)

Other models:

531 — 1,602 kHz (with 9 kHz tuning interval)

530 — 1,610 kHz (with 10 kHz tuning interval)

### Antenna:

AM loop antenna

### Antenna terminals:

External antenna terminal

### Intermediate frequency:

450 kHz

## Speaker

### Front speaker (SS-GZR9D) for MHC-GZR9D

### Front speaker (SS-GZR8D) for MHC-GZR8D/GZR7D

#### Speaker system:

3-way, Bass reflex, Magnetically shielded

#### Speaker unit

Subwoofer: 130 mm, cone type

Woofer: 130 mm, cone type

Tweeter: 40 mm, horn type

Rated impedance: 6 ohms

Dimensions (w/h/d):

Approx. 250 × 350 × 255 mm

Mass:

Approx. 4.6 kg

### Surround speaker (SS-RSX9D) for MHC-GZR9D/GZR8D

#### Speaker system:

1-way, Bass reflex

#### Speaker unit

Full-range: 80 mm, cone type

Rated impedance: 6 ohms

Dimensions (w/h/d):

Approx. 174 × 96 × 113 mm

Mass:

Approx. 640 g

### Center speaker (SS-CTX9D) for MHC-GZR9D/GZR8D

#### Speaker system:

1-way, Bass reflex, Magnetically shielded

#### Speaker unit

Full-range: 80 mm, cone type

Rated impedance: 6 ohms

Dimensions (w/h/d):

Approx. 230 × 97 × 117 mm

Mass:

Approx. 920 g

### Subwoofer (SS-WGV9D) for MHC-GZR9D

#### Speaker system:

Subwoofer system, Bass reflex, Magnetically shielded

#### Speaker unit

Subwoofer: 200 mm, cone type

Rated impedance: 6 ohms

Dimensions (w/h/d):

Approx. 270 × 325 × 340 mm

Mass:

Approx. 6.2 kg

## General

### Power requirements

Russian model:

AC 230 V, 50/60 Hz

Australian model:

AC 230 – 240 V, 50/60 Hz

Thai model:

AC 220 V, 50/60 Hz

Saudi Arabian model:

AC 120 – 127, 220, 230 – 240 V,

50/60 Hz, adjustable with voltage

selector

Other models:

AC 120, 220, 230 – 240 V, 50/60 Hz,

adjustable with voltage selector

### Power consumption

MHC-GZR9D: 270 W (Russian  
model: 0.5 W in Power Saving Mode)

MHC-GZR8D: 240 W

MHC-GZR7D: 170 W (Russian  
model: 0.5 W in Power Saving Mode)

### Dimensions (w/h/d) (excl. speakers)

MHC-GZR9D/GZR8D:

Approx. 280 × 325 × 415 mm

MHC-GZR7D:

Approx. 280 × 325 × 382 mm

### Mass (excl. speakers)

MHC-GZR9D: Approx. 12 kg

MHC-GZR8D: Approx. 11.5 kg

MHC-GZR7D: Approx. 10.5 kg

### Supplied accessories:

Remote Commander (1)

AM loop antenna (1)

FM lead antenna (1)

Video cord (1)

Speaker pads (MHC-GZR9D (24),

MHC-GZR8D (20), MHC-GZR7D  
(8))

Speaker cords (3) (MHC-GZR9D/  
GZR8D only)

KARAOKE DVD disc (2) (Russian  
model only)

Microphone (1) (Russian and

Philippine models only)

R6 (Size AA) batteries (2)

Design and specifications are subject to  
change without notice.



- Standby power consumption:  
0.5 W
- Halogenated flame retardants are  
not used in the printed wiring  
boards.

## Guide to the Control Menu display

Use the Control Menu to select a function and to view related information. Press DISPLAY **25** repeatedly to turn on, turn off or change the Control Menu display as follows:

Control Menu display 1 → Control Menu display 2 (appears for certain discs and USB devices only) → Control Menu display off → Control Menu display 1 → ...

### Control Menu display



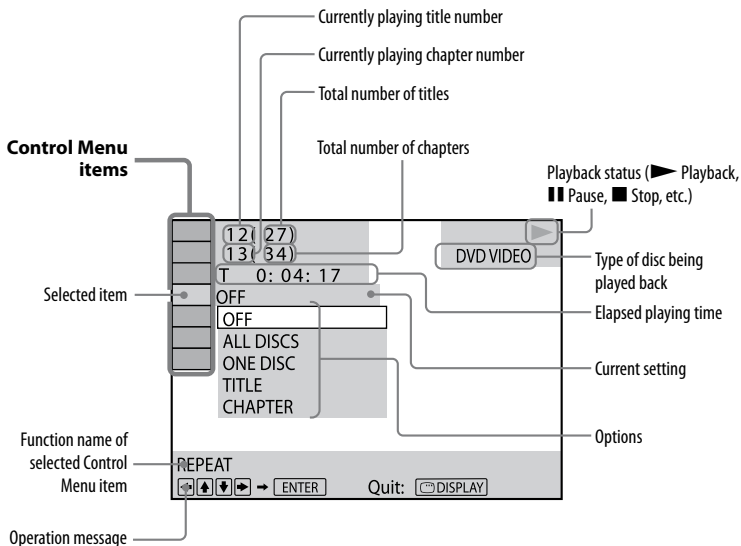



The Control Menu display 1 and 2 will show different items depending on the disc type. Example: Control Menu display 1 when playing a DVD VIDEO









### To turn off the Control Menu







Press DISPLAY **25** repeatedly until the Control Menu disappears from the TV screen.

## List of Control Menu items

Item	Item Name, Function, Relevant Disc Type
	<b>[TITLE] (page 50)/[SCENE]/[TRACK] (page 50)</b> Selects the title, scene, or track to be played back. <b>DVD-V</b> <b>DVD-VR</b> <b>VIDEO CD</b>
	<b>[CHAPTER]/[INDEX] (page 50)</b> Selects the chapter or index to be played back. <b>DVD-V</b> <b>DVD-VR</b> <b>VIDEO CD</b>
	<b>[TRACK]<sup>1)</sup> (page 50)</b> Selects the track to be played back. <b>C D</b> <b>DATA CD</b> <b>DATA DVD</b>
	<b>[ORIGINAL/PLAY LIST] (page 49)</b> Selects the playback sequence either to the originally recorded sequence or to the playlist created on the disc. <b>DVD-VR</b>
	<b>[TIME]<sup>1)</sup> (page 51)</b> Checks the elapsed playing time and the remaining time. Inputs the time code for picture and music searching. <b>DVD-V</b> <b>DVD-VR</b> <b>VIDEO CD</b> <b>C D</b> <b>DATA CD</b> <b>DATA DVD</b>
	<b>[PROGRAM] (page 44)</b> Plays back the tracks in the order you want. <b>VIDEO CD</b> <b>C D</b>
	<b>[SHUFFLE]<sup>1)</sup> (page 46, 91)</b> Plays back the tracks in random order. <b>VIDEO CD</b> <b>C D</b> <b>DATA CD</b> <b>DATA DVD</b>

Item	Item Name, Function, Relevant Disc Type
	<p><b>[REPEAT]<sup>1)</sup> (page 47, 92)</b>  Plays back all discs repeatedly, the entire disc (all titles/all tracks/all folders) repeatedly or one title/chapter/track/folder/file repeatedly.</p> <p><b>DVD-V</b> <b>DVD-VR</b> <b>VIDEO CD</b> <b>C D</b> <b>DATA CD</b> <b>DATA DVD</b></p>
	<p><b>[A/V SYNC] (page 59)</b>  You can adjust the delay between the picture and sound.</p> <p><b>DVD-V</b> <b>DVD-VR</b> <b>VIDEO CD</b> <b>DATA CD</b> <b>DATA DVD</b></p>
	<p><b>[SETUP]<sup>1)</sup> (page 36, 63)</b>  <b>QUICK</b>  Use “QUICK” Setup to choose the language of the on-screen display and the aspect ratio of the TV.  <b>CUSTOM</b>  In addition to the “QUICK” setup setting, you can adjust other settings.</p> <p><b>DVD-V</b> <b>DVD-VR</b> <b>VIDEO CD</b> <b>C D</b> <b>DATA CD</b> <b>DATA DVD</b></p>
	<p><b>[FOLDER]<sup>1)</sup> (page 50)</b>  Selects the folder to be played back.</p> <p><b>DATA CD</b> <b>DATA DVD</b></p>
	<p><b>[FILE]<sup>1)</sup> (page 50)</b>  Selects the JPEG image file or DivX video file to be played back.</p> <p><b>DATA CD</b> <b>DATA DVD</b></p>
	<p><b>[DATE]<sup>1)</sup> (page 112)</b>  Displays the date when the picture was taken by a digital camera.</p> <p><b>DATA CD</b> <b>DATA DVD</b></p>
	<p><b>[INTERVAL]<sup>1)</sup> (page 56, 90)</b>  Specifies the duration for which the slides are displayed on the TV screen.</p> <p><b>DATA CD</b> <b>DATA DVD</b></p>

Continued 

Item	Item Name, Function, Relevant Disc Type
	<p><b>[EFFECT]<sup>1)</sup> (page 57, 91)</b>            Selects the transition effects to be used for changing slides during a slide show.</p> <p style="text-align: right;"><b>DATA CD</b> <b>DATA DVD</b></p>
	<p><b>[MODE (MUSIC, IMAGE)]<sup>1)</sup> (page 55, 87, 88)</b>            For DATA CD/DVD, selects the data type: MP3 audio track (MUSIC), JPEG image file (IMAGE) or both (AUTO) to be played back.            For USB device, selects the data type: audio track (MUSIC) or JPEG image file (IMAGE) to be played back.</p> <p style="text-align: right;"><b>DATA CD</b> <b>DATA DVD</b></p>
	<p><b>[USB RECORDING] (page 80)</b>            Transfers tracks on an AUDIO CD or DATA CD/DVD to an USB device.</p> <p style="text-align: right;"><b>C D</b> <b>DATA CD</b> <b>DATA DVD</b></p>
	<p><b>[KARAOKE MODE]<sup>1)</sup> (page 98)</b>            Sets Karaoke mode to on or off.</p> <p style="text-align: right;"><b>DVD-V</b> <b>DVD-VR</b> <b>VIDEO CD</b> <b>C D</b> <b>DATA CD</b> <b>DATA DVD</b></p>
	<p><b>[SCORE MODE]<sup>1)2)</sup> (page 103)</b>            Calculates your vocal score by comparing your voice with the music source.</p> <p style="text-align: right;"><b>DVD-V</b> <b>DVD-VR</b> <b>VIDEO CD</b> <b>C D</b> <b>DATA CD</b> <b>DATA DVD</b></p>
	<p><b>[VOCAL SELECT]<sup>2)</sup> (page 102)</b>            Selects the guide vocal recorded on the “Dolby Digital Karaoke” Format disc (DVD VIDEO only).            Selects the vocal type recorded on the disc (VIDEO CD, AUDIO CD only).            Turns off the vocal.</p> <p style="text-align: right;"><b>DVD-V</b> <b>VIDEO CD</b> <b>C D</b></p>

<sup>1)</sup> These functions are the same when using an USB device. However, some menu items may not be available.

<sup>2)</sup> This function is only available during Karaoke mode.

# Language code list

The language spellings conform to the ISO 639:1988 (E/F) standard.

Code	Language	Code	Language	Code	Language	Code	Language
1027	Afar	1186	Scots Gaelic	1350	Malayalam	1513	Siswati
1028	Abkhazian	1194	Galician	1352	Mongolian	1514	Sesotho
1032	Afrikaans	1196	Guarani	1353	Moldavian	1515	Sundanese
1039	Amharic	1203	Gujarati	1356	Marathi	1516	Swedish
1044	Arabic	1209	Hausa	1357	Malay	1517	Swahili
1045	Assamese	1217	Hindi	1358	Maltese	1521	Tamil
1051	Aymara	1226	Croatian	1363	Burmese	1525	Telugu
1052	Azerbaijani	1229	Hungarian	1365	Nauru	1527	Tajik
1053	Bashkir	1233	Armenian	1369	Nepali	1528	Thai
1057	Byelorussian	1235	Interlingua	1376	Dutch	1529	Tigrinya
1059	Bulgarian	1239	Interlingue	1379	Norwegian	1531	Turkmen
1060	Bihari	1245	Inupiak	1393	Occitan	1532	Tagalog
1061	Bislama	1248	Indonesian	1403	(Afan) Oromo	1534	Setswana
1066	Bengali; Bangla	1253	Icelandic	1408	Oriya	1535	Tonga
1067	Tibetan	1254	Italian	1417	Punjabi	1538	Turkish
1070	Breton	1257	Hebrew	1428	Polish	1539	Tsonga
1079	Catalan	1261	Japanese	1435	Pashto; Pushto	1540	Tatar
1093	Corsican	1269	Yiddish	1436	Portuguese	1543	Twí
1097	Czech	1283	Javanese	1463	Quechua	1557	Ukrainian
1103	Welsh	1287	Georgian	1481	Rhaeto-Romance	1564	Urdu
1105	Danish	1297	Kazakh	1482	Kirundi	1572	Uzbek
1109	German	1298	Greenlandic	1483	Romanian	1581	Vietnamese
1130	Bhutani	1299	Cambodian	1489	Russian	1587	Volapük
1142	Greek	1300	Kannada	1491	Kinyarwanda	1613	Wolof
1144	English	1301	Korean	1495	Sanskrit	1632	Xhosa
1145	Esperanto	1305	Kashmiri	1498	Sindhi	1665	Yoruba
1149	Spanish	1307	Kurdish	1501	Sangho	1684	Chinese
1150	Estonian	1311	Kirghiz	1502	Serbo-Croatian	1697	Zulu
1151	Basque	1313	Latin	1503	Singhalese	1703	Not specified
1157	Persian	1326	Lingala	1505	Slovak		
1165	Finnish	1327	Laothian	1506	Slovenian		
1166	Fiji	1332	Lithuanian	1507	Samoa		
1171	Faroese	1334	Latvian; Lettish	1508	Shona		
1174	French	1345	Malagasy	1509	Somali		
1181	Frisian	1347	Maori	1511	Albanian		
1183	Irish	1349	Macedonian	1512	Serbian		

## Parental Control area code list



<b>Code</b>	<b>Area</b>	<b>Code</b>	<b>Area</b>	<b>Code</b>	<b>Area</b>	<b>Code</b>	<b>Area</b>
2044	Argentina	2165	Finland	2362	Mexico	2149	Spain
2047	Australia	2174	France	2376	Netherlands	2499	Sweden
2046	Austria	2109	Germany	2390	New Zealand	2086	Switzerland
2057	Belgium	2248	India	2379	Norway	2528	Thailand
2070	Brazil	2238	Indonesia	2427	Pakistan	2184	United Kingdom
2079	Canada	2254	Italy	2424	Philippines		
2090	Chile	2276	Japan	2436	Portugal		
2092	China	2304	Korea	2489	Russia		
2115	Denmark	2363	Malaysia	2501	Singapore		



---

## Glossary

### Auto Pause

An automatic pause according to the signal encoded on the disc while playing a VIDEO CD. If the CD/DVD player does not resume play for a long time, press  (or press  on the unit)  to resume play manually.

### Chapter

Subdivision of a title on a DVD VIDEO. A title is composed of several chapters.

### Digital Cinema Sound (DCS)

This is the generic name of the surround sound produced by digital signal processing technology developed by Sony. Unlike previous surround sound fields mainly directed at the reproduction of music, Digital Cinema Sound is designed specifically for the enjoyment of movies.

### DivX®

Digital video technology created by DivX, Inc. Videos encoded with DivX technology are among the highest quality with a relatively small file size.

### Dolby Digital

This movie theater sound format is more advanced than Dolby Surround Pro Logic. In this format, the surround speakers output stereo sound with an expanded frequency range and a subwoofer channel for deep bass is independently provided. This format is also called “5.1” because the subwoofer channel is counted as 0.1 channel (since it functions only when a deep bass effect is needed). All six channels in this format are recorded separately for superior channel separation. Furthermore, since all the signals are processed digitally, less signal degradation occurs.

### Dolby Pro Logic II

Dolby Pro Logic II creates five full-bandwidth output channels from 2 channel sources. This is done using an advanced, high-purity matrix surround decoder that extracts the spatial properties of the original recording without adding any new sounds or tonal colorations.

### Movie mode

The Movie mode is for use with stereo television shows and all the programs encoded in Dolby Surround. The result is enhanced sound field directionality that approaches the quality of discrete 5.1-channel sound.

### Music mode

The Music mode is for use with any stereo music recordings, and provides a wide and deep sound space.

## **Dolby Surround Pro Logic**

As one method of Dolby Surround, Dolby Surround Pro Logic produces four channels from 2channel sound. Compared with the former Dolby Surround system, Dolby Surround Pro Logic reproduces left-to-right panning more naturally and localizes sounds more precisely. To take full advantage of Dolby Surround Pro Logic, you should have one pair of surround speakers and a center speaker. The surround speakers output monaural sound.

## **DTS**

Digital audio compression technology developed by DTS, Inc. This technology conforms to 5.1-channel surround. The surround channel is stereo and there is discrete subwoofer channel in this format. DTS provides the same 5.1 discrete channels of high quality digital audio. The good channel separation is realized because the all channel data is recorded discrete and processed in digital.

## **DVD VIDEO**

A disc that contains up to 8 hours of moving pictures even though its diameter is the same as an AUDIO CD. The data capacity of a single-layer and single-sided DVD VIDEO, at 4.7 GB (Giga Byte), is 7 times that of an AUDIO CD. Furthermore, the data capacity of a dual-layer and single-sided DVD VIDEO is 8.5 GB, a single-layer and double-sided DVD VIDEO 9.4 GB, and a dual-layer and double-sided DVD VIDEO 17 GB. The picture data uses the MPEG 2 format, one of the worldwide standards for digital compression technology. The picture data is compressed to about 1/40 of its original size. The DVD VIDEO also uses variable rate coding technology that changes the data to be allocated according to the status of the picture. The audio data is recorded in Dolby Digital as well as in PCM, allowing you to enjoy more realistic audio presence. Furthermore, various advanced functions such as the multi-angle, multilingual, and Parental Control functions are provided with the DVD VIDEO.

## **DVD-RW**

A DVD-RW is a recordable and rewritable disc that is the same size as a DVD VIDEO. The DVD-RW has two different modes: VR mode and Video mode. DVD-RWs created in Video mode have the same format as a DVD VIDEO, while discs created in VR (Video Recording) mode allow the contents to be programmed or edited.

**DVD+RW**

A DVD+RW (plus RW) is a recordable and rewritable disc. DVD+RWs use a recording format that is comparable to the DVD VIDEO format.

**File**

A JPEG image file or DivX video file recorded on a DATA CD, DATA DVD or USB device. ("File" is an exclusive definition for this system.) A single file consists of a single image.

**Film based software, Video based software**

DVD VIDEOS can be classified as Film based or Video based software. Film based DVD VIDEOS contain the same images (24 frames per second) that are shown at movie theaters. Video based DVD VIDEOS, such as television dramas or sitcoms, displays images at 30 frames (or 60 fields) per second.

**Folder**

Section of a music or picture piece on a DATA CD, DATA DVD or USB device containing MP3 audio tracks, JPEG image files, DivX video files.

**Interlace format (Interlaced scanning)**

The Interlace format is the NTSC standard method for displaying TV images at 30 frames per second. Each frame is scanned twice-alternately between the even numbered scanning lines and then odd numbered scanning lines, at 60 times per second.

**Menu Playback**

Playback using the menu screens recorded on VIDEO CDs with PBC functions. You can enjoy simple interactive software using the menu playback function.

**Multi-angle function**

Various angles, or viewpoints of the video camera, for a scene are recorded on some DVD VIDEOS.

**Multilingual function**

Several languages for the sound or subtitles in a picture are recorded on some DVD VIDEOS.

**Multi Session**

This is a recording method that enables adding of data using the Track-At-Once method. Conventional CDs begin at a CD control area called the Lead-in and end at an area called Lead-out. A Multi Session disc is a disc having multiple sessions, with each segment from Lead-in to Lead-out regarded as a single session.

## Parental Control

A function of the DVD VIDEO to limit playback of the disc by the age of the users according to the limitation level in each country. The limitation varies from disc to disc; when it is activated, playback is completely prohibited, violent scenes are skipped or replaced with other scenes and so on.

## Playback Control (PBC)

Signals encoded on VIDEO CDs (Version 2.0) to control playback. By using menu screens recorded on VIDEO CDs with PBC functions, you can enjoy playing simple interactive programs, programs with search functions, and so on.

## Progressive format (sequential scanning)

In contrast to the Interlace format, the progressive format can reproduce 50 — 60 frames per second by reproducing all scanning lines (525 lines for the NTSC system, 625 lines for PAL system). The overall picture quality increases and still images, text and horizontal lines appear sharper. This format is compatible with the 525 or 625 progressive format.

## Region Code

This system is used to protect copyrights. A region code is allocated on each DVD system or DVD VIDEO according to the sales region. Each region code is shown on the unit as well as on the disc packaging. The system can play back the discs that match its region code. The system can also play back discs with the “” mark. Even when the region code is not shown on the DVD VIDEO, the region limit may still be activated.

## Scene

On a VIDEO CD with PBC functions, the menu screens, moving pictures and still pictures are divided into sections called “scenes.”

## Title

The longest section of a picture or a music piece on a DVD VIDEO; a movie, etc., for a picture piece on video software, or the entire album in audio software.

## Track

Section of a picture or a music piece on a VIDEO CD, CD, or MP3. A folder is composed of several tracks (MP3 only).

## VIDEO CD

A compact disc that contains moving pictures.

The picture data uses the MPEG 1 format, one of the worldwide standards for digital compression technology. The picture data is compressed to about 1/140 of its original size. Consequently, a 12 cm VIDEO CD can contain up to 74 minutes of moving pictures.

VIDEO CDs also contain compact audio data.

Sounds outside the range of human hearing are compressed while the sounds we can hear are not compressed. VIDEO CDs can hold 6 times the audio information of conventional AUDIO CDs.

There are 2 versions of VIDEO CDs.

- Version 1.1: You can play back only moving pictures and sounds.
- Version 2.0: You can play back high-resolution still pictures and enjoy PBC functions.

This system conforms to both versions.

# Index

## Numerics

- 16:9 65
- 4:3 LETTER BOX 65
- 4:3 PAN SCAN 66
- 5.1 Channel Surround 112, 115

## A

- A/V SYNC 59, 141
- AAC 85
- ANGLE 40
- AUDIO 65
- AUDIO DRC 67
- AUDIO SETUP 67
- Auto Pause 145

## B

- BACKGROUND 68
- Batteries 25
- BLACK LEVEL 66
- BLACK LEVEL  
(COMPONENT OUT) 66

## C

- CHAPTER 47, 140
- Chapter 39, 145
- COLD RESET 129
- COLOR SYSTEM (VIDEO CD) 66
- COMPONENT VIDEO OUT 28, 114
- Controlling the TV 29
- Control Menu Display 139
- CUSTOM 28, 60, 63

## D

- DATA CD 7
- DATA DVD 8
- DATE 141
- Demonstration 107
- Digital Cinema Sound (DCS) 145
- DIGITAL MEDIA PORT 114
- DivX 57, 145
- Dolby Digital 145
- Dolby Pro Logic II 145
  - Movie mode 145
  - Music mode 145
- Dolby Surround Pro Logic 146
- DTS 146
- DVD 7, 8
- DVD+RW 7, 147
- DVD-RW 7, 146
- DVD VIDEO 146

## E

- EFFECT 57, 91, 142

## F

- Fast forward 39
- Fast reverse 39
- FILE 48, 141
- File 147
- Film based software 147
- FOLDER 48, 92, 141
- Folder 147
- Freeze Frame 39
- Front panel display 19

## I

- INDEX 50, 140
- Instant Advance 39
- Instant Replay 39
- Interlace format 147
- INTERVAL 56, 90, 141

## J

- JPEG 52, 53, 55, 88

## K

- Karaoke 98
  - ECHO 99
  - KARAOKE MODE 98, 142
  - Karaoke Pon 101
  - Key Control 101
  - SCORE MODE 103, 142
  - VOCAL SELECT 102, 142

## L

- Language code list 143
- LANGUAGE SETUP 34, 64

## M

- Manual recording 75
- MENU 65
- Menu Playback 147
- Microphones 98
- Microphone volume 99
- MODE (MUSIC, IMAGE) 55, 142
- MP3 7, 85
- Multi-angle 40, 147
- MULTI-DISC RESUME 44, 68
- Multilingual 147
- Multi Session Disc 10, 147

**O**

ORIGINAL 49, 140  
OSD 65  
Other Component Hookup  
113

**P**

PARENTAL CONTROL 60  
Parental Control 148  
PAUSE MODE 66  
PBC Playback 42  
Playback Control (PBC) 148  
PLAY LIST 49, 140  
PROGRAM 44, 140  
Program Play 44  
PROGRESSIVE  
(COMPONENT OUT)  
28, 66  
Progressive format 148

**Q**

Quick setup display 34

**R**

Radio 71  
Radio Stations 71  
Rear panel 113  
REC 1 79  
Recording 75, 83  
Region Code 148  
Remote 13  
REPEAT 47, 92, 141  
Repeat Play 47, 92  
RESET 130  
Resume Play 43

**S**

SCENE 140  
Scene 148  
SCREEN SAVER 67  
Searching 49  
SETUP 141  
Setup Menu 63  
SHUFFLE 46, 91, 140  
Shuffle Play 46, 91  
Sleep Timer 105  
Slide Show 53, 88  
Slow-motion Play 39  
Sound Field 95  
SPEAKER SETUP 68  
SUBTITLE 65  
S VIDEO 114  
Synchronized transfer 79  
Synchro recording 75  
SYSTEM SETUP 67

**T**

TEST TONE 70  
THEATRE SYNC 36  
TIME 51, 140  
Timer 105  
TITLE 47, 140  
Title 49, 148  
TRACK 46, 92, 140  
Track 7, 8  
TRACK SELECTION 67  
Transferring 78  
Troubleshooting 118  
TV Hookup 26  
TV TYPE 65

**U**

Unit 12  
Usable discs 7  
USB 78  
USB device 78  
USB RECORDING 80, 142

**V**

VIDEO CD 7, 149  
VIDEO SETUP 34, 65

**W**

WMA 85